

Wood Destroying Pest Control

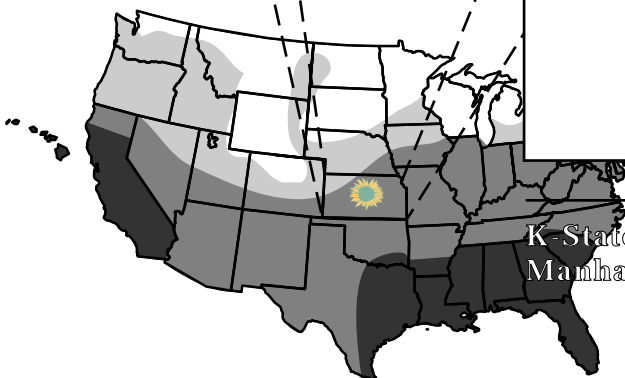
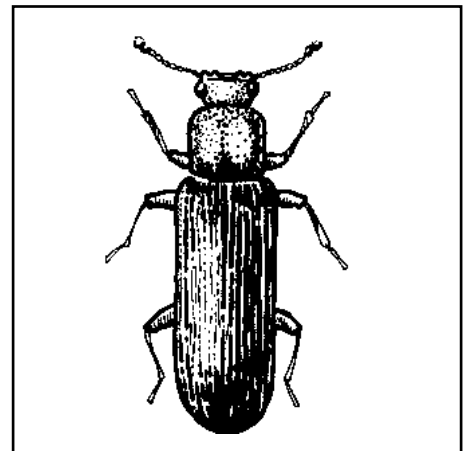
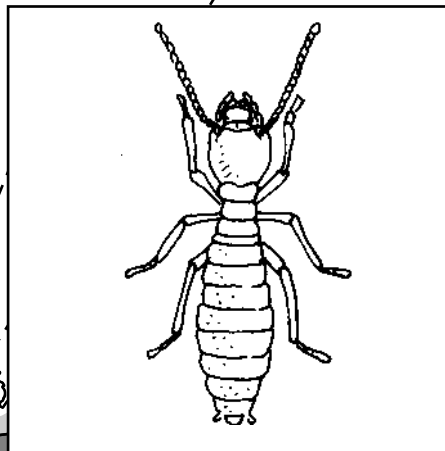
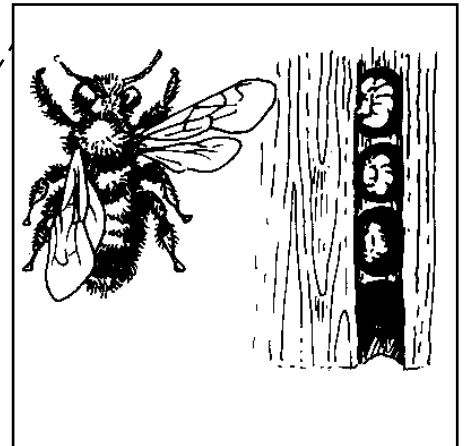
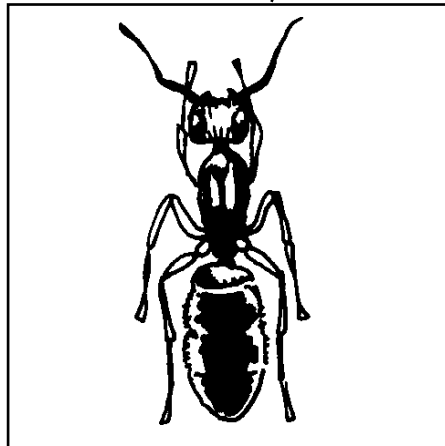



Table of Contents

Introduction	4
Biology of Termites	5
Colony Structure	
Colony Formation	
Termite Identification	
Termite Detection	
Other Wood Destroying Organisms	10
Drywood termites	
Powderpost beetles	
Longhorned beetles	
Carpenter ants	
Carpenter bees	
Wood decay fungi	
Key to insect damage of wood	
Chemicals Applied for Termite Control	16
Pyrethroids	
Borates	
Organophosphates/Carbamates	
Insect Growth Regulators (IGR's)	
Biological Agents	
Structural and Treatment Considerations	19
Diagrams of basic structural members and forms	
Soil Treatment for Subterranean Termites	22
Preconstruction Treatment	
Post Construction Treatment	
Exterior Treatment Methods	
Interior Treatment Methods	
Treatment Guidelines	
Avoiding Contamination	29
Spill Control	
Special Tools and Techniques	
Special Treatments	33
Crawl Spaces	
Sub-Slab Heating Ducts	
Basements	
Veneers	
Hollow block, tile, and rubble foundations	
Wells, Cisterns, and other water sources	
Rigid foam insulation	
Wood Treatment	
Baiting Technology	37
Fumigation	40
Selection of Fumigants	
Types of Fumigation	
Precautions and Protective Equipment	
Respiratory Protection Devices	
Safe Use of Fumigants	

Directions for Using this Manual

This is a self-teaching manual. At the end of each major section is a list of study questions to check your understanding of the subject matter. By each question in parenthesis is the page number on which the answer to that question can be found. This will help you in checking your answers.

These study questions are representative of the type which are on the certification examination. By reading this manual and answering the study questions, you should be able to gain sufficient knowledge to pass the Kansas Commercial Pesticide Applicators Certification and Recertification examination.

Introduction



Several species of insects damage wood in buildings in Kansas. There also are wood decaying fungi in Kansas. It is important that the commercial pest control operator can distinguish between damage caused by fungi and insects. Correct pest identification and extent of infestation is essential before any control measures are applied.

Required Records or Statement of Services

The records required by commercial applicators are outlined in the Laws and Regulations section in the General Manual. Questions on required records will be included in the 7A examination, especially those requirements that are for wood-destroying organisms. A diagram of the structure is absolutely essential for all wood-destroying organisms.

Applicators are responsible for following the termite control application procedures specified in the Kansas Pesticide Law (K.A.R. 4-13-7).

References for Your Library

There are a number of good references on fumigation and pests controlled by fumigation. The Manual of Fumigation for Insect Control published by the Food and Agriculture Organization (available from UNIPUB, Incorporated, 650 First Avenue, P.O. Box 433, New York, New York 10016) has a very thorough coverage of fumigants and fumigation. Handbook of Pest Control, by Arnold Mallis, MacNair-Dorland Company has a good section on fumigation. Urban Entomology, by Walter Ebeling, University of California, Division of Agriculture, Berkeley, California Science. 1975. An excellent reference to wood-destroying pests is Truman's Scientific Guide to Pest Control Operations by Purdue University (Edgall Communications, Duluth, MN).

Biology of Termites

Termites belong to the insect order Isoptera. In nature, termites are considered beneficial because they break down dead and dying plant material. It is when termites feed on wooden structures that they become pests. Three types of termites occur in the United States; dampwood, drywood and subterranean termites.

Subterranean termites of the family Rhinotermitidae occur throughout Kansas and are the kind most commonly encountered. Subterranean termites nest in the soil from which they obtain their moisture. They may attack any wood in contact with the soil. If there is no direct wood to soil contact, the termites may build mud tubes or tunnels within the cracks of foundations or over the outside of concrete to reach wood several feet above the ground.

To a limited extent, termites are capable of regulating temperature conditions in the colony. Their galleries often are situated so some run above ground and some below. Therefore, during extremes of hot and cold weather, the termites will be found below the ground where the conditions are more equitable.

Subterranean termites need a constant, ample supply of moisture. Part of this moisture is procured from the products of their own metabolism and part from soil moisture which diffuses throughout their tunnels or tubes. Since the subterranean termite colony usually obtains its moisture from the soil, they are generally dependent on soil types. Moisture in clay soils is tightly bound to the particles and not readily available to the termite. Sandy soils allow more moisture to be available and, consequently, these termites are more prevalent and able to survive in sandy soils.

Fungi, when present in the wood, will serve as another source of moisture. These fungi aid in the regulation of humidity in the galleries. The plugs of partially chewed





food and feces placed by the termites in the passages also assist in moisture regulation.

Occasionally, subterranean termites can be found above ground, isolated from the soil. This can occur if moisture is available from a source other than the soil. Common sources include condensation, and leaking pipes and roofs.

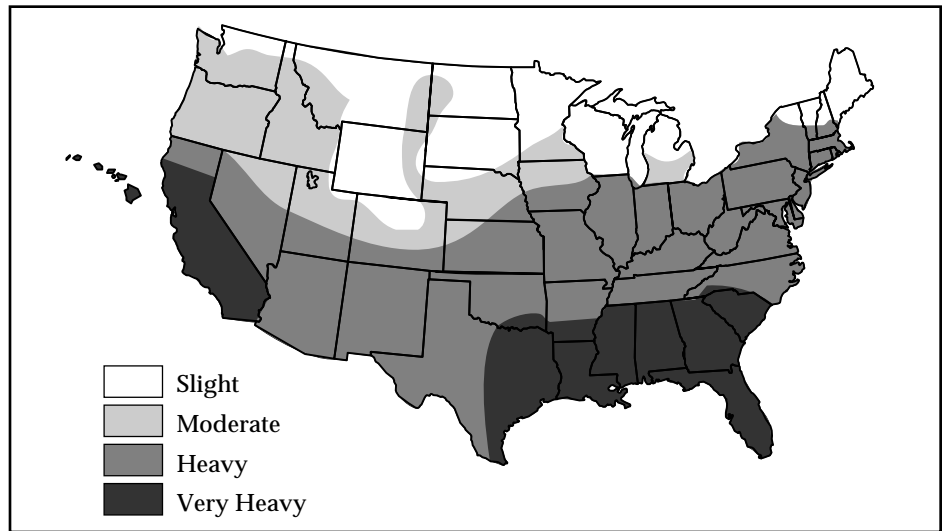
Wood is made up primarily of cellulose, a large complex chain of relatively simple chemical molecules. Few animals have the necessary body chemistry to break down cellulose into smaller, more usable nutrients. Termites accomplish this by the presence of protozoa in their hindgut. These protozoa break down the cellulose into products that the termites can digest. If these protozoa are removed, the termites will eventually die of starvation.

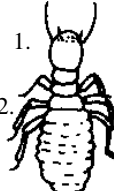
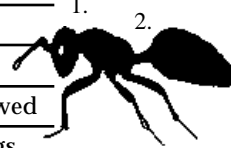
Termite Map

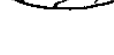

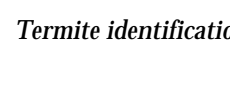
Termite	Four Ways to Tell Termites From Ants		Ant
	Compare These Features		
1. 	1. Eyes absent	1. Eyes present	1. 
2. 	2. Waist thick	2. Waist thin	2. 
3. 	3. Antenne not elbowed	3. Antenne elbowed	3. 
4. 	4. Two pair wings of equal length	4. Two pair wings of unequal length	4. 

Termite identification

Biology of Termites

The most important and most prevalent subterranean termite in Kansas is the Eastern Subterranean Termite *Reticulitermes flavipes* (Kollar). This species also occurs in Mexico and in the Mediterranean area of Europe. It attacks wooden structures and also has been known to infest telephone poles, fence posts and occasionally living trees, shrubbery, flowers and crops.

Termite Identification

It is the primary reproductives which are most often discovered by the homeowner. Many people confuse this winged form with flying ants which also can be found swarming near structures. Termites can be distinguished from ants by comparing their physical characteristics. Winged termites (alates) have straight antennae, thick waists, and four, long fragile wings of equal size and shape. Winged ants have a wasp-like body shape, narrow waists and two forewings which are larger than the two rear wings.

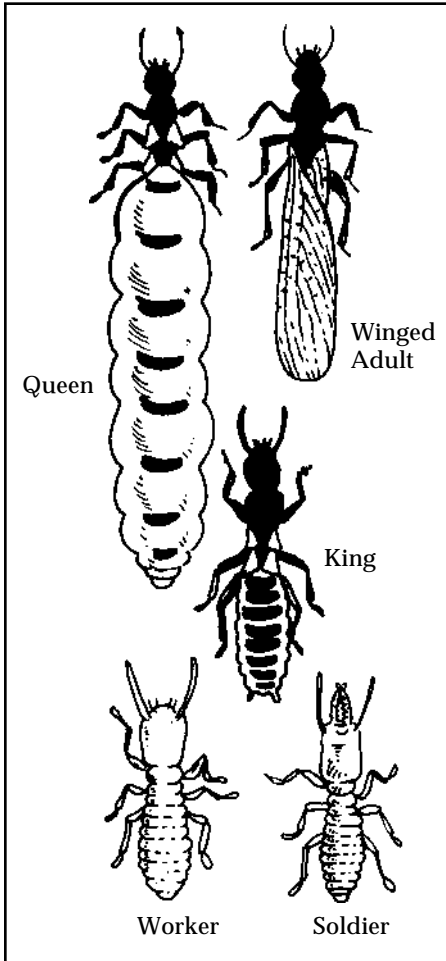

Colony structure

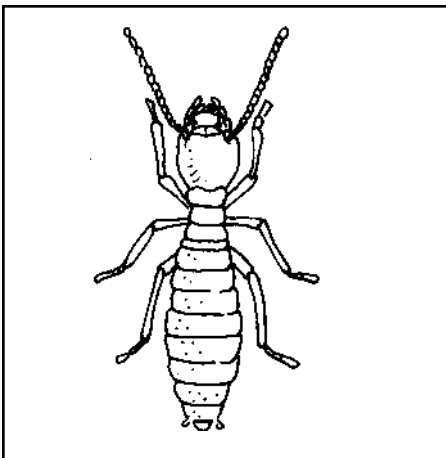

Worker termite

The workers maintain the shelter tubes and close any breaks in the surface of the wood they are infesting with the same material. Termites must have this closed system to maintain the necessary high level of humidity. The tubes also serve as a protective barrier against their natural enemies, especially ants. Occasionally, a colony may find a source of moisture in the wood from a leaking pipe or roof, for example, so contact with the soil is no longer necessary.

Termite workers are sometimes misnamed "white ants" and can be found in large numbers in forest logs, wood lying in contact with the ground, or in the lumber in buildings. Workers mature within a year and live three to five years.

Soldiers

Soldiers have greatly enlarged, dark, reddish-brown heads and sword-like mandibles. There are a relatively small number of soldiers. The soldier's job is to guard the colony against predators, primarily ants. The soldiers are so specialized that they cannot feed themselves, so they are fed by the workers. Both the workers and soldiers are sterile. Soldiers mature within one year and live three to five years.

Reproductive

There are two types of reproductive termites: primary and secondary. The primary reproductives have wings (alate) and are produced in mature colonies (3 to 5 years and older). They have dark-colored, flattened bodies, and large eyes. Their two pairs of wings are equal in length and narrow. The wings are used for a single, usually short, flight after which they break off near the base. There are both males and females. The queens may lay over 60,000 eggs during her 25-year life time.

Secondary reproductives develop under certain conditions in growing colonies. There are both males and females and they are wingless.

Colony Structure

Subterranean termites live in colonies below ground. The subterranean termite colony is made up of various types or castes. Each caste is specialized for certain jobs or functions. The three castes of subterranean termites are: (1) worker, (2) soldier and (3) reproductive.

Workers

Worker termites are creamy-white, wingless, eyeless insects and they are by far the most numerous in the colony. They are very soft-bodied and subject to drying out (desiccation). Their primary moisture (humidity) source comes from the soil. Their primary function is to perform the actual work of the colony. They build the shelter tubes from bits of soil and excretions as passageways from the nest to the food source. They find and eat wood, maintain galleries within the wood, groom and feed the king, queen, and feed the soldiers.

Biology of Termites

Female secondary reproductives supplement the egg production of the primary queen. There is a potential for the secondary reproductives to be present within the structure.

Colony Formation

Swarming of the Eastern Subterranean Termite, in Kansas, usually occurs in April or May. The reproductives are stimulated to break out of the colony by a warm day after a spring rain. The rule of thumb is that swarming generally will occur within 10 days following a warm spring rain. Several swarms may occur from the same colony and usually the first swarm is the largest. Not all colonies will swarm every year.

The swarm is a dispersal flight and usually will contain equal numbers of both male and female reproductives. As the termites fall to the ground, after a short fluttering flight, their wings break off. Males and females pair off and begin excavation for a new nest. Subterranean termites usually burrow under trees or decaying wood on or in the soil. They rarely use the crevices of trees to initiate the colony. In a swarm there are many termites which never find a mate or a "homesite." Others are eaten by predators such as birds and lizards.

Once a pair find a site and seal themselves in, they will mate, and the female (queen) will begin egg laying. The first batch will be small usually consisting of six to 24 eggs. Once these nymph workers hatch, they begin to eat cellulose and enlarge the colony area. With a larger number of nymphs, the queen will lay increasingly larger numbers of eggs. Reproductive forms will not be produced in the first year. It takes three to five years for a newly established colony to begin to do serious damage to structural wood. At this time, the colony population begins a faster rate of increase because the secondary reproductives also begin to lay eggs to supplement those laid by the queen. There is not

one central nest containing one queen. Secondary reproductives may be found at locations throughout the colony.

Another way colonies may be formed is by "budding" from a well-established colony. Sometimes a number of individuals, including one or more secondary reproductives, leave the colony and start a new one. This type of colony formation is referred to as "budding."

Buildings with stone or concrete foundations offer temporary obstacles to termites. If a crack $\frac{1}{64}$ inch in width develops in these foundations, termites can enter and move into the wood above unless some other barrier is present or is added. Remember, termites can build shelter tubes across foundations to reach wood, if distances are relatively short. So cracks on concrete, continuous openings in building blocks, utility openings, expansion joints, and wood below soil level offer the best and easiest access for termites.

Termite Detection

Subterranean termites remain hidden within the wood. Those actually doing the feeding (the workers) are seldom seen. However, the presence of termites can be detected in several ways. Termites usually come to the attention of the homeowner in the spring when the winged reproductives swarm.

The presence of a termite swarm emerging out-of-doors near the structure does not necessarily mean that the structure is infested. However, this is a good reason to investigate further. If the swarmers emerge inside, they will be attracted to light and their broken-off wings may be found near windows and doors.

When looking for signs of termite activity, the inspector must also be alert for those conditions that favor termite infestations. The most critical condition is wood to soil contact. **The USDA Forest service has identified 15 conditions that frequently lead to termite infestations.**

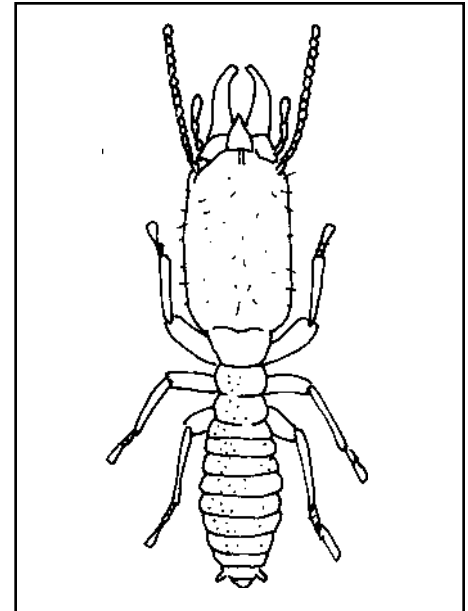

Soldier termite

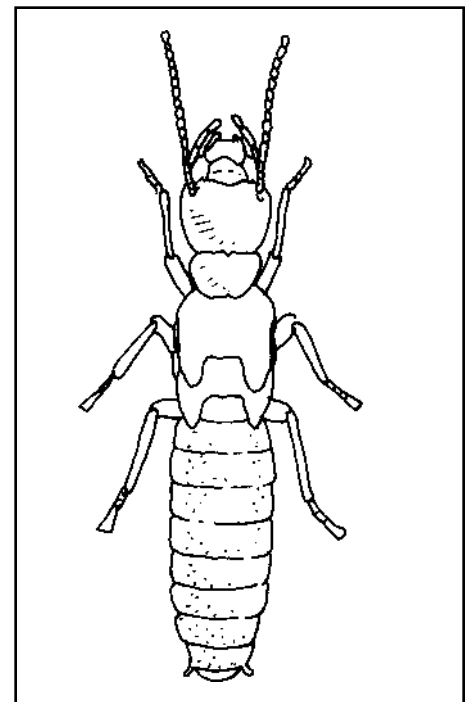

Secondary reproductive

Biology of Termites

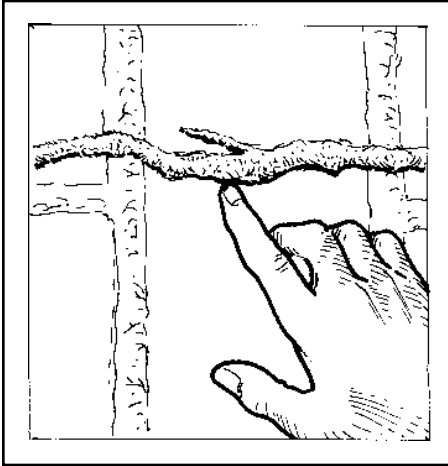

Termite tube

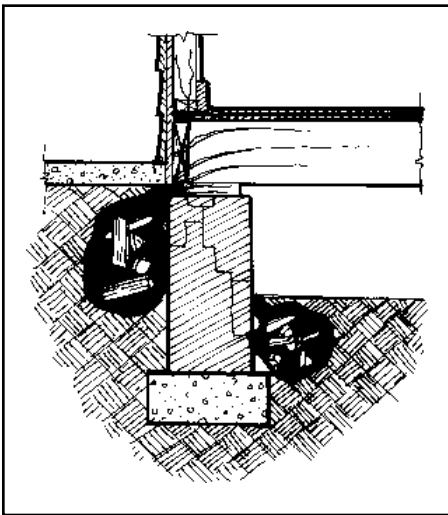

Termite colony in a structure

1. Cracks in concrete foundations and open voids in concrete foundation are hidden avenues of entry.
2. Any wooden posts or supports set in concrete, may be in contact with the soil underneath.
3. Concrete porches with earth fill may provide wood to soil contact.
4. Form boards left in place contribute to the termite food supply.
5. Leaking pipes and dripping faucets in the crawl space keep the soil under the structure moist.
6. Blocking crawl space vents with shrubbery will cause the air under the structure to remain damp and warm.
7. Construction debris in the backfill beside the structure will contribute to the termites food supply.
8. Low foundation walls and footings will provide wood to soil contact.
9. Stucco or brick veneer carried down over the concrete foundation allows for hidden access to the structure.
10. Soil filled planters built up against the side of the structure allows direct access into foundation cracks.
11. Forms left in slabs where plumbing drains enter the structure provide access.
12. Wooden porch steps in contact with the soil provide direct wood to soil contact.
13. Heating units in the crawl space maintain warm soil for termite colonies year-round.
14. Paper is a wood product. Paper collars around pipes and ducts can provide access to the structure.
15. Wooden fences, trellises and other adornments against the side of the structure provide access.

If any of these conditions exist they should be carefully inspected and if possible, corrected.

Damaged wood is often not noticed and the exterior surface usually must be removed to see the damage. However, galleries can be detected by tapping the wood every few inches with a screwdriver. Damaged wood will sound hollow and the screwdriver may even break through into the galleries. Subterranean termite feeding follows the grain of the wood and only the soft springwood is eaten. The galleries will contain soil and fecal particles. Subterranean termites do not push wood particles or pellets (fecal material) outside the galleries as do other wood boring insects, but rather use them in the construction of their tunnels.

Termites can detect vibrations through their legs. They are unable to hear noises near their nests but are immediately aroused when their nest is tapped. When alarmed, the soldier termites rattle their heads against the gallery walls to initiate the vibrations which will warn the colony. Under certain circumstances it is possible to hear this "ticking" sound.

Other signs of infestation are the presence of flattened, earthen shelter tubes that the termites build over the surface of the foundation to reach the wood. These tubes are usually $\frac{1}{4}$ to $\frac{1}{2}$ inch wide. Termites perish rapidly under dry conditions and build these mud tubes to maintain correct humidity throughout the colony. Buildings should be inspected at least once a year for evidence of tubes. In concrete slab construction, closely examine the expansion joints and cracks where pipes and ducts go through the slab.

Termite colonies can develop in wood debris and soil, and gain entrance into a building, particularly at concrete entrance slabs of porches.

Biology of Termites

Questions

1. (5) Termites belong to the insect order:
 - a. Isoptera
 - b. Coleoptera
 - c. Diptera
 - d. Hymenoptera
2. (5) Termites are more prevalent in _____ soils.
 - a. clay
 - b. silty
 - c. sandy
 - d. gravel
3. (6) The most numerous members in a termite colony are the:
 - a. workers
 - b. soldiers
 - c. primary reproductives
 - d. secondary reproductives
4. (6) The termite cast with the greatly enlarged dark, reddish brown heads are the:
 - a. workers
 - b. soldiers
 - c. primary reproductives
 - d. secondary reproductives
5. (7) The first batch of eggs laid by the queen in a new termite colony is:
 - a. 6–12 eggs
 - b. 50–75 eggs
 - c. 100–150 eggs
 - d. 200–300 eggs
6. (7) Termites can enter structures through:
 - a. cracks in concrete
 - b. utility openings
 - c. expansion joints
 - d. all the above
7. (8) When looking for signs of termites, the inspector should look for:
 - a. forms left in slabs around plumbing drains
 - b. wooden porch steps in soil contact
 - c. wooden fences, trellises contacting the structure
 - d. all the above
8. (8) Buildings should be inspected at least once _____ for termites tubes.
 - a. a year
 - b. every 4 years
 - c. every 8 years
 - d. every 15 years

Other Wood

Destroying Organisms

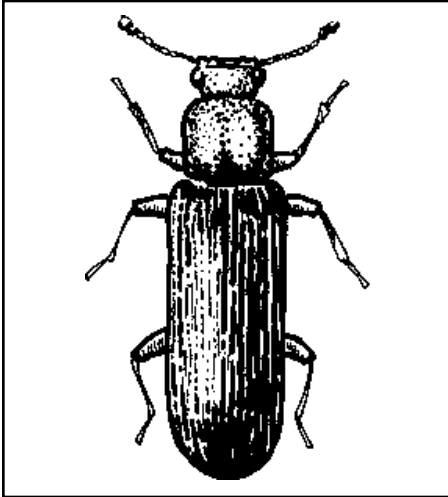

Lyctid beetle

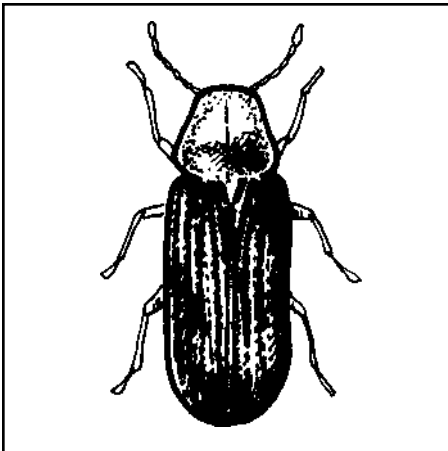

Anobiid beetle

Drywood Termites

Drywood termites are rarely found in Kansas. When they are, their origin can usually be traced to furniture or other wood moved into Kansas from one of the southern states.

Drywood termites directly attack wood and make galleries in it, rather than below ground. As they feed, they cut across the ligneous grain of wood, excavating large galleries which are connected by small tunnels. They produce hard fecal pellets with six distinct concave surfaces on the sides. These pellets often are pushed out of the infested wood through small holes.

Control small, localized infestations of drywood termites by injecting insecticides through holes drilled into the termite galleries. Furniture and other movable objects may be fumigated in special fumigation chambers. High temperatures of 140°F for four hours or low temperatures of 15°F for four days will kill these termites.

Powderpost Beetles

There are three families of powderpost beetles. The most common are the Lyctid and Anobiid powderpost beetles. The Bostrichids are the least common family. The adults are small and usually reddish-brown to nearly black.

Small "shot hole" exit openings in the wood surfaces are an indication of a powderpost beetle infestation. Slight jarring of the wood causes a fine powder to sift from these holes. When the wood is cut or broken, the interior reveals galleries filled with a finely-packed powder produced by the feeding of grub-like larvae. Joists, subflooring, hardwood flooring, sills, plates, and interior trim are the parts of buildings most frequently attacked. Furniture and other wood products also may be damaged.

Lyctid Powderpost Beetle

The true powderpost adult is small, slender, flattened, and reddish-brown to black in color. It varies in length from about 1/8 to 1/4 inch long. The female lays her eggs in the pores of the wood. So hardwoods, since they have pores, are the likely woods to be infested. Only the sapwood of these hardwoods is eaten since only it contains the starch required in the diet of these beetles. Once hatched, young larvae bore into the wood. Unlike termites, they are unable to digest cellulose. Consequently, most of the wood eaten passes through the larva and is left behind as a powdery frass. Thus, lyctid damage is characterized by the fine powder falling from the surface holes in hardwoods.

Anobiid Beetles

These include the furniture and deathwatch beetles. Anobiid beetles are usually slightly less than 1/8 inch long, red to brown to black in color. Their eggs are deposited in cracks and crevices of all types of seasoned wood. But these beetles seem to prefer the sapwood of softwood trees. Unlike the other powderpost beetles, anobiids have a digestive enzyme which allows them to digest cellulose. An infestation is characterized by a coarse powdery frass containing bun-shaped fecal pellets.

Within this group, the furniture beetle will infest structural wood as well as furniture.

The deathwatch beetle prefers structural timbers in damp areas. Its name comes from the habit of the adult in making a ticking sound that can be heard in the quiet of the night. Joists, subflooring, hardwood flooring, sill plates, and interior trim are the parts of buildings deathwatch beetles most frequently attack. In addition, they may damage furniture and other products.

Bostrichid Powderpost Beetle

The adult of the false powderpost beetle is more robust than that of the true powderpost beetle. Its body is

Other Wood

Destroying

Organisms

cylindrical with a roughened thorax surface. Its head usually is not visible from above. Color varies from dark brown to black and length from $\frac{1}{8}$ to 1 inch. Like the true powderpost beetles, it digests the starch in the wood, but not the cellulose. However, false powderpost beetles will attack softwoods as well as hardwoods.

To prevent infestations or to control existing infestations, treat wood surfaces. Furniture and other movable objects may be fumigated in special chambers.

Longhorned Beetles (Cerambycidae)

Longhorned beetles are large ($\frac{1}{2}$ to 3 inches long) and many are brightly colored. They have long, thin antennae which may be longer than the body. Eggs usually are laid on unseasoned, rough-sawed timbers or logs. The larvae, called round-headed borers, feed in the wood. They bore large, oval holes as they move through wood.

The most common structural pest of this family is the old-house borer. The adult is about $\frac{3}{4}$ inch long, grayish-brown to black, and has two white patches on the wing covers. The old-house borer damages only soft woods such as pine. It can be recognized by ripples on the surface of the galleries.

For control, infested wood may be drilled to allow penetration into infested areas. Fumigation under a tarpaulin sometimes may be necessary.

Carpenter Ant (Camponotus spp.)

The carpenter ant occurs widely in the United States and is one of the largest of our common ants. The adults vary in length from $\frac{1}{4}$ inch for small workers to $\frac{3}{4}$ inch for a queen. The body is dark brown to black in color.

Carpenter ants seek soft, generally moist wood to establish their nests;

particularly wood that has weathered and begun to decay. Although the nest is most often begun in the soft wood, later excavations frequently are made into perfectly sound, dry lumber. They may be found in porch columns and roofs, window sills, hollow core doors, wood scraps in dirt-filled slab porches, and wood in contact with soil.

An infestation in a building may be started by a single fertilized female. But many times it is started by a colony or portion of a colony moving in from another location. This is especially true in wooded areas. The queen sheds her wings when the new colony is started and remains wingless the rest of her life. The males are winged individuals and die soon after the mating flight is over. Winged forms usually are not produced in a colony until it is at least three years old. A large colony can cause serious structural damage if not controlled.

Carpenter ants do not eat wood (in contrast with termites), but excavate galleries in the wood to rear their young. Carpenter ants eject the wood in the form of a coarse sawdust. The characteristic sawdust piles aid in nest location. They feed on honeydew excreted by aphids, upon other insects, animal remains, and household food scraps.

The damage of carpenter ants is easily distinguished from that of termites. Their galleries are excavated without regard for the grain and follow the softer portions of the wood. The galleries are kept smooth and clean, having a sandpapered appearance. Termite galleries are not smooth and clean.

When carpenter ants are found within a structure, the colony is either nesting within the building or they are nesting outside the building and entering to forage for food. Houses near wooded areas are especially subject to invasion.

The key to the control of carpenter ants is locating the nest or nests. This is the most important part of their

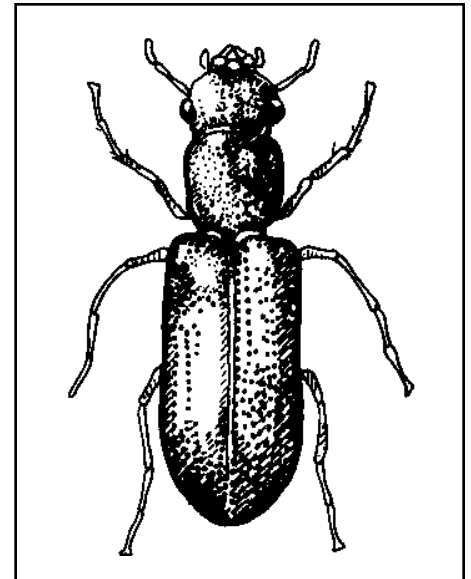

Bostrichid beetle

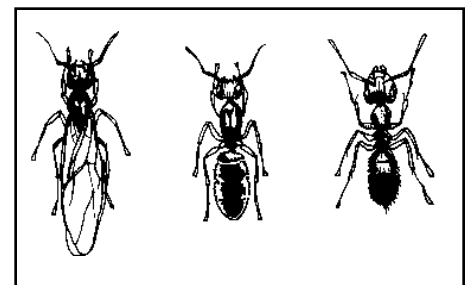

Carpenter ant—winged female and two workers

Other Wood

Destroying Organisms

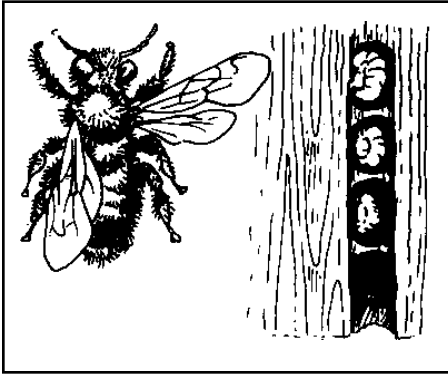

Carpenter Bee

control and sometimes the most difficult. If the nest or nests can be found, there is an excellent chance of controlling this pest. Elimination of the nest outside may be just as important as one established in the building. In some cases, an entire colony may migrate from one nesting site to another—from a tree outdoors to structural timber indoors.

As an aid to finding the nest indoors, examine these suggested locations:

- wood affected by water seepage (porch floors, roofs, porch posts and columns).
- wood in contact with soil.
- wood adjacent to dirt-filled slab porches.

Carpenter ants are usually found associated with a moisture condition. Some signs of carpenter ants to look for when inspecting for a nest indoors are:

- piles of coarse “sawdust” on the floor or foundation.
- ant activity, since they frequently forage for food in kitchens.
- However, even when the nest is in a building, very few ants may be seen. They are usually active at night and often forage outside.
- firewood piled in garages or next to a house.

Some of the things to look for outdoors are:

- firewood, stumps, logs and trees that might contain nests.
- trees with branches hanging over and touching the roof of a house. Ants may travel over these branches into the building.

Sanitation measures such as removing and destroying logs and stumps that harbor nests will help eliminate the pest. Protection of structures from carpenter ants requires destruction of the nests in and near the structure.

Apply insecticides to the nest and nest areas. Spraying or dusting the infested area without locating and treating the nest usually does not provide complete control.

Carpenter Bee (*Xylocopa virginica*)

Carpenter bees are large ($\frac{3}{4}$ to 1 inch long), heavy-bodied insects. Their blue-black metallic bodies will have some yellow or orange hair. They resemble bumble bees but can be distinguished by their shiny, black, hairless abdomens. The abdomen of the bumble bee is yellow and hairy. Bumble bees also have large pollen baskets on their hind legs.

In the spring, carpenter bees become a nuisance as they fly erratically, close to homes and other buildings. Males hover like humming birds, waiting for females to emerge so they can mate. If the males are disturbed, they may hover or buzz around the head of a person. Only the females sting; then only if molested. After the mating season, most of the summer is spent loitering around the nest or nearby flowers.

Aside from the nuisance of having carpenter bees around, they also bore into seasoned woods, especially soft woods such as cedar, redwood, pine and fir. Damage may occur to soft or weathered woods on porches, decks, shed ceilings, railings, overhead trim, porch furniture, dead tree limbs, fence posts, wooden shingles, wood siding, window sills and wood doors. The female bees bore circular holes, about $\frac{1}{2}$ -inch wide, into the wood at right angles to the surface, for about an inch. Then they turn sharply, boring in the direction of the wood grain for 4 to 6 inches.

Structural damage caused by one or two carpenter bees is slight. However, tunnels may be used again and lengthened by other broods. The activities of numerous bees over a period of years is certain to cause some structural damage.

Carpenter bees overwinter in wood as young adults. The tunnels are made by the females. Those bees that survive the winter, mate in the spring (April to June) and then begin preparation for the next brood.

Other Wood

Destroying

Organisms

Carpenter bees do not eat the wood they tunnel in, but use these tunnels for rearing the young. The female provides her tunnel-nest with "bee bread" (a mixture of pollen and regurgitated nectar) which serves as food for the larvae when the eggs hatch. She makes a cell for each larva and closes each cell with chewed wood pulp. There may be as many as six to eight cells in the tunnel. The time required to complete development from egg to adult varies from one to three months. Though newly-formed adult bees usually emerge in late August, these bees will not mate to start the cycle over again until the following spring.

Painted wood is rarely attacked by carpenter bees, so keep all exposed wood surfaces well painted. Wood stains will not prevent attacks. Pressure treated wood with a preservative should be used if painting is not practical.

Treatment involves applying insecticide into the tunnel entrance. Treat the opening after dark when the bees are less active. Do not plug the holes, but allow the bees to pass freely so they can contact the insecticides. The holes should be filled a day or two later to prevent further use.

Wood Decay Fungi

Severe wood decay occurs only in wood with a moisture content greater than 20 percent. Most wood-rotting fungi grow only on wood subject to wetting by rain, roof leaks, plumbing leaks, condensation, or contact with moist soil. Two species, however, can conduct water directly to wood.

Fungi take their food from the wood as they grow and reduce the strength of wood, often making it brown and crumbly or white and stringy. Do not confuse discoloration and powdery mold growth below the surface of wood with decay. The moisture content of the wood may be measured with a moisture meter to accurately determine the need for control.

Fungicides will not stop wood decay once it has started, though they sometimes slow its progress. The key to complete control of wood decay is to eliminate the source of moisture.

This may be done through:

- proper drainage
- breaking contact between wood and soil
- ventilation
- the use of vapor barriers
- other good construction practices

Pressure treating lumber with preservative chemicals before use may prevent attack by wood-destroying fungi.

Key to Insect Damage to Wood and Wood Products

1. In processed wood, numerous small holes resembling those made by bird-shot in surface of wood. If piece split open, many frass-filled tunnels can be seen, most of them running with the grain..... Powderpost Beetles
 - Exit holes $\frac{1}{16}$ to $\frac{1}{8}$ inch in diameter. More advanced galleries running across the grain. Frass consists in part of distinct elongate or bun-shaped pellets. In hard and soft wood Family: Anobiidae
 - Exit holes vary from $\frac{1}{8}$ to $\frac{3}{8}$ inch in diameter due to reentrance as well as emergence of adult. Occasional tunnels going crosswise to the grain but majority with the grain. Fine or coarse frass which tends to stick together; few if any pellets. In hardwoods such as ash, oak and hickory; sometimes in softwoods Family: Bostrichidae
 - Exit holes $\frac{1}{32}$ to $\frac{1}{16}$ inch in sapwood of hardwood lumber in not too old condition. (Common in poorly seasoned lumber). Frass abundant in tunnels but readily "powders-out." No pellets in powder Family: Lyctidae
2. In either processed wood or rough timber, occasional holes, round or elliptical, considerably larger in size than buckshot. Irregular and rather extensive

Other Wood

Destroying

Organisms

- tunnels in the sapwood with usually coarse, packed frass..... Roundhead or Longhoned Beetles
Usually heavy damage of this sort in finished wood. Often, only external evidence of injury is one or two oval exit holes to the outside Old-House Borer
3. In rough, bark-covered wood, small escape holes about 1/8 inch in size. Inner side of bark and surface of wood itself “engraved” with galleries (old damage, can’t reinfest dried wood. No control required) Shothole or Bark Beetle
4. Pinholes and slender galleries in sapwood, frequently of southern yellow pine. The burrows and area around them stained dark by the action of fungi (old damage, can’t reinfest dried wood. No control required) Ambrosia Beetle
5. No openings (or at best, very seldom and then they are usually sealed over). Galleries extensive lengthwise usually in the springwood and packed with a hard, mastic-like frass. May infest many old cellulose objects near or in contact with the soil..... Subterranean Termite
6. Wood often with distinct round openings to outside, when split open, it reveals very thorough excavation. Galleries contain considerable coarse, hard, sand-like frass, each pellet having rounded ends and six longitudinal depressions. No mastic-like frass or very fine powder Drywood Termites
7. Timbers with extensive galleries which are sandpaper smooth, often with rounded edges, and containing no frass. Coarse sawdust may be found near damage Carpenter Ants
8. Wood with 1/3 to 1/2 inch round holes on side, edge, or end, leading into long tunnel (3 to 24 inches). If hole is on side of wood, tunnel turns right angles and continues with the grain of the wood. Carpenter Bees
- Adapted from a release by Department of Entomology, Purdue University, West Lafayette, Indiana.

Other Wood Destroying Organisms

Questions

1. (10) Small “shot hole” openings in wood surfaces are an indication of _____ infestation.
 - a. powderpost beetle
 - b. drywood termite
 - c. dampwood termite
 - d. subterranean termite
2. (10) Beetles in the family _____ have an enzyme which allows them to digest cellulose.
 - a. Bostrichida
 - b. Lyctidae
 - c. Anobiidae
 - d. Carbididae
3. (11) The most common structural pest in the longhorned beetle family is the:
 - a. Bronze birch borer
 - b. Old-house borer
 - c. Cherry-shelf borer
 - d. Powderpost beetle
4. (11) Carpenter ant nests can be found in:
 - a. window sills
 - b. hollow core doors
 - c. wood in contact with soil
 - d. all the above
5. (12) Carpenter bees are large, heavy insects with
 - a. blue-black metallic bodies
 - b. red-orange shiny bodies
 - c. light and dark green striped bodies
 - d. light tan bodies
6. (13) Carpenter bees feed their young:
 - a. wood from the tunnel
 - b. bee bread
 - c. other insects
 - d. seeds from flowers
7. (13) The key to complete control of wood decay fungi is to:
 - a. treat with borates
 - b. treat with insecticides
 - c. eliminate the moisture source
 - d. lower the temperature to 45°F

Chemicals

Applied for

Termite Control



Pyrethroids

The pyrethroids are a large family of modern synthetic insecticides that are similar to the natural pyrethrins. They are highly repellent compounds to termites which may contribute to the effectiveness of the termiticide barrier. They have been modified to increase their stability in the natural environment. They are widely used in agriculture, homes and gardens. Some examples include: cyfluthrin, cypermethrin, deltamethrin and permethrin.

Pyrethroids are formulated as emulsified concentrate (EC), wettable powder (WP), granular (G), and Aerosols. They may be applied alone or in combination with other insecticides.

Although certain pyrethroids exhibit striking neurotoxicity in laboratory animals when administered by intravenous injection, and some are toxic by the oral route, systemic toxicity by inhalation and dermal absorption is low. There have been very few systemic poisonings of humans by pyrethroids. Although limited absorption may account for the low toxicity of some pyrethroids, rapid biodegradation by mammalian liver enzymes (ester hydrolysis and oxidation) is probably the major factor responsible. Most pyrethroid metabolites are promptly excreted, at least in part, by the kidney.

Extraordinary absorbed doses may rarely cause incoordination, tremor, salivation, vomiting, diarrhea, and irritability to sound and touch. Extreme doses have caused convulsions in laboratory animals. Some persons may experience a skin sensitivity (paresthesia) with symptoms similar to "sunburn" sensation of the face and especially the eyelids. This is a temporary effect that dissipates within 24 hours. If this condition occurs, washing in water and the use of vitamin E creams may help alleviate the condition. Persons experiencing this condition should

opt for a different pyrethroid active ingredient, limit their exposure, or choose a formulation of wettable powder or micro-encapsulation.

Borates

Borate is a generic term for compounds containing the elements boron and oxygen. Boron never occurs alone naturally, but as calcium and sodium borate ores in several places in the world.

Borax and other sodium borates are used in numerous products such as laundry additives, eye drops, fertilizers, and insecticides. While its toxic mechanisms are not fully understood, boron is very toxic to insects and decay fungi that commonly damage wood in structures. However, boron is only minimally toxic, and perhaps beneficial at low levels, to humans and other mammals. Use of borate-treated wood for construction of homes and their wood-based contents appears to offer many advantages to today's environmentally sensitive world.

Unlike most other wood preservatives and organic insecticides that penetrate best in dry wood, borates are diffusible chemicals—they penetrate unseasoned wood by diffusion, a natural process. Wood moisture content and method and length of storage are the primary factors affecting penetration by diffusion.

Properly done, diffusion treatments permit deep penetration of large timbers and refractory (difficult-to-treat) wood species that cannot be well treated by pressure treatment. The diffusible property of borates can be manipulated in many ways; suitable application methods range from complex, automated industrial processes to simple brush or injection treatments.

Application methods include a wide array such as: momentary immersion by bulk dipping, pressure or combination pressure/diffusion treatment, treatment of composite boards and laminated products by treatment of the "wood furnish," hot

Chemicals

Applied for

Termite Control

and cold dip treatments and long soaking periods, spray or brush-on treatments of wood with borate slurries or pastes, and placement of fused borate rods in drilled holes in wood in use.

Organophosphates and Carbamates

These are two very large families of insecticides. Indeed they have been the primary insecticides for the past 25 to 30 years. They range in toxicity from slightly to highly toxic. They are formulated in all kinds of ways from highly concentrated EC to very dilute G formulations.

These insecticide families are similar in their mode of action. They are all nervous system poisons. Insects and all other animals including humans have nervous systems that are susceptible. Both families are efficiently absorbed by inhalation, ingestion, and skin penetration. To a degree, the degree of poisoning depends on the rate at which the pesticide is absorbed. For organophosphates, breakdown occurs chiefly by hydrolysis in the liver; rates of hydrolysis vary widely from one compound to another. In the case of certain organophosphates whose breakdown is relatively slow, significant temporary storage in body fat may occur.

The organophosphates and carbamates replaced the chlorinated hydrocarbons for all uses, including termite control. At the present time, the pyrethroids are gaining significantly in some aspects of termite applications.

Insect Growth Regulators

The insect growth regulator (IGR) chemicals are often synthetic mimics

of insect hormones. Hormones regulate a wide array of body and growth (physiological) functions. Some examples include interfering with molting, interfering with pupal emergence, and interfering with body wall formation.

IGRs often are specific for an insect species or group of very closely related species. They often have delayed effects because they are taken into the insect and “stored” until the insect reaches the right growth stage. This may range from days to weeks or even months. For example, if the IGR stops the insect from molting, and a given insect is exposed just after a molt, it would continue to function normally until the next molt before dying.

In the case of termite control, the slow action of the IGR allows the chemical to be widely spread throughout the colony as the termite workers feed and groom each other.

The IGRs are, in general, environmentally safe and they have very low mammalian toxicity. Some examples include hexaflumuron, pyriproxyfen and fenoxycarb.

Biological Agents

Biological control agents such as disease causing fungi and bacteria, and parasitic nematodes continue to be studied as possible termite control or termite reduction options. In some cases, these agents will be released into the soil and in other cases, they will be injected into the above-ground termite galleries.

As with all new methods of control, more research is needed to determine the advantages and limitations of such organisms.

Chemicals

Applied for

Termite Control

Questions

1. (16) A large family of synthetic insecticides closely related to the natural pyrethrins are the:
 - a. borates
 - b. phosphates
 - c. pyrethroids
 - d. carbarnates
2. (16) Borate is a term for compounds containing:
 - a. carbon and hydrogen
 - b. calcium and sodium
 - c. lead and argon
 - d. boron and oxygen
3. (16) Application methods of borates to wood may include
 - a. momentary immersion
 - b. pressure treatment
 - c. spray or brush-on
 - d. all the above
4. (17) Organophosphate insecticides are broken down in humans mainly in the:
 - a. liver
 - b. kidney
 - c. blood
 - d. skin
5. (17) An example of how an insect growth regulator functions in an insect is by:
 - a. interfering with respiration
 - b. interfering with mobility
 - c. interfering with molting
 - d. interfering with sight
6. (17) Biological control of termites may include the use of such agents as:
 - a. fungi
 - b. bacteria
 - c. nematodes
 - d. all the above

Structural and Treatment Considerations

Types of Construction

Knowing the type of construction (basement, slab or crawl space) is important. Each construction type

has unique areas vulnerable to termite entry. This is particularly true of slab construction. It is important to remember that termites can enter through any crack, crevice or expansion joint as small as $\frac{1}{64}$ of an inch.

Diagrams Identifying Structural Members

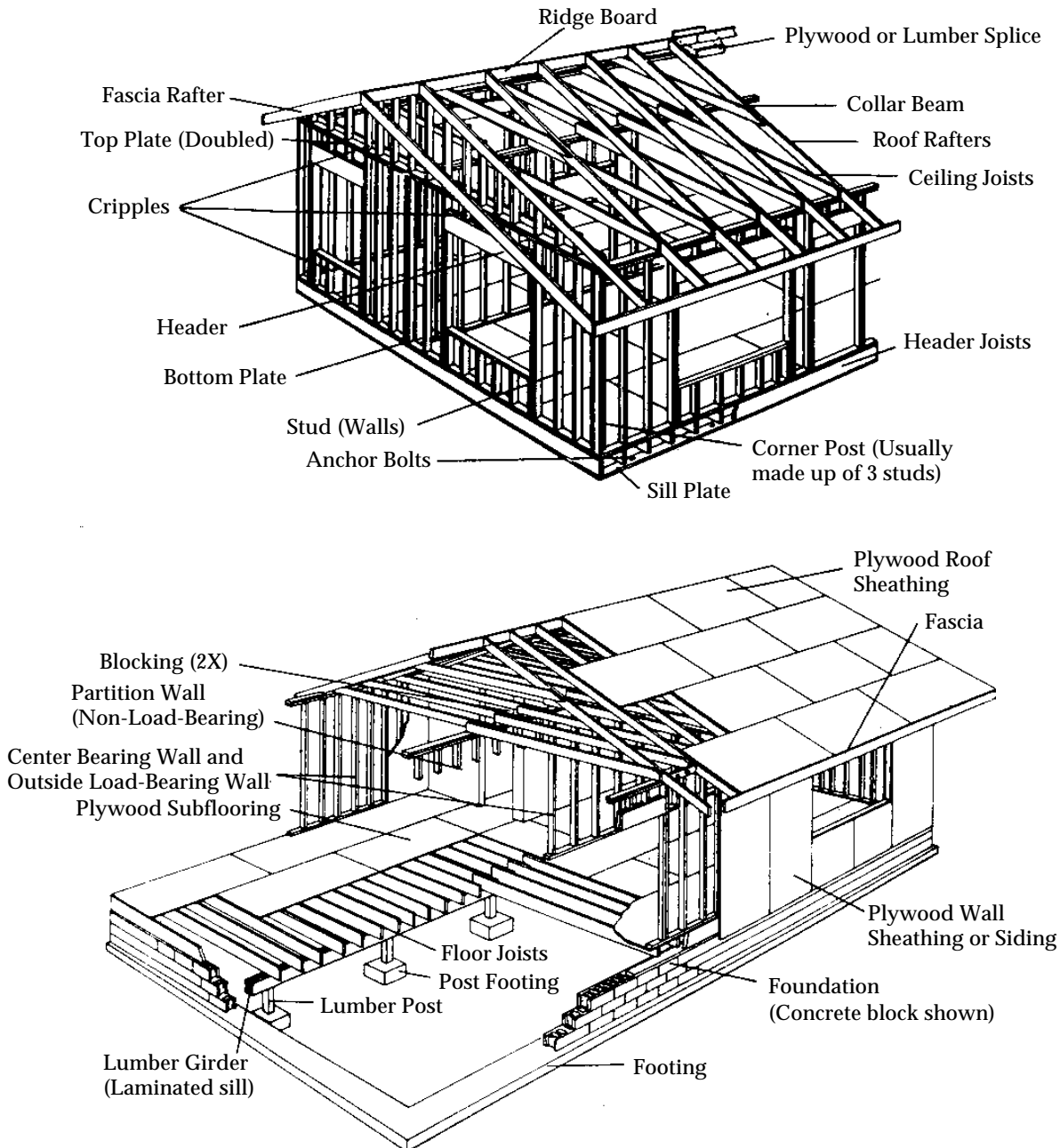

Structural and Treatment Considerations

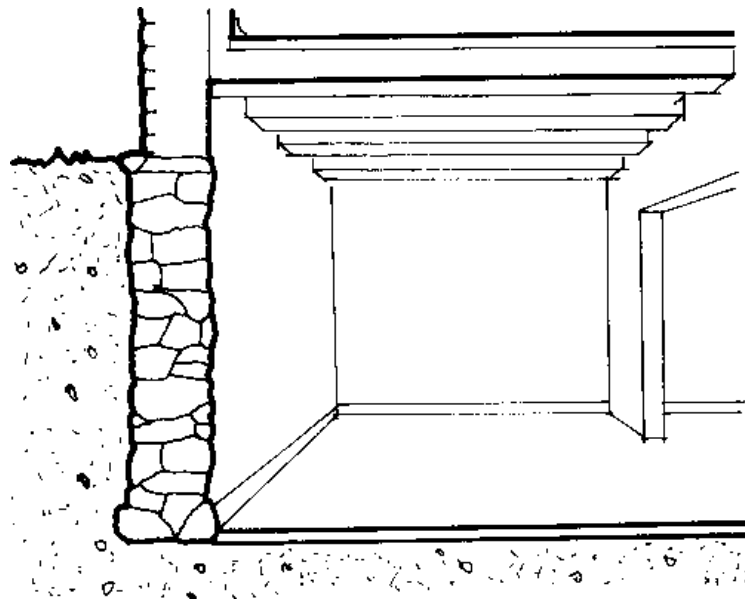

Basement Construction

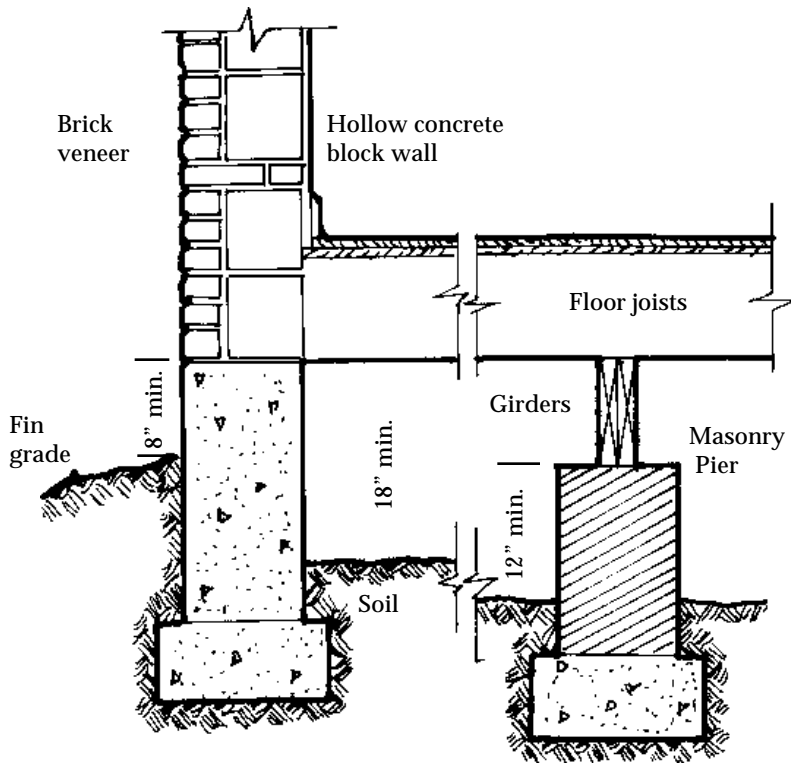

Crawl Space Construction

Structural and Treatment Considerations

Slab Construction

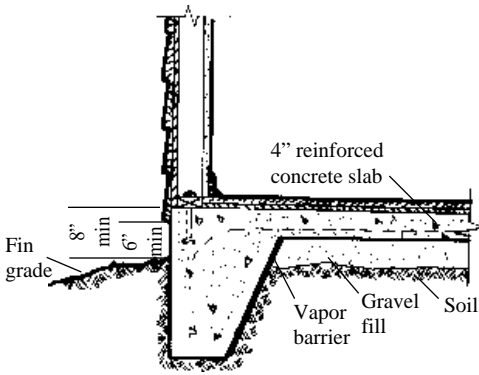

Monolithic Concrete Slab-on-Ground

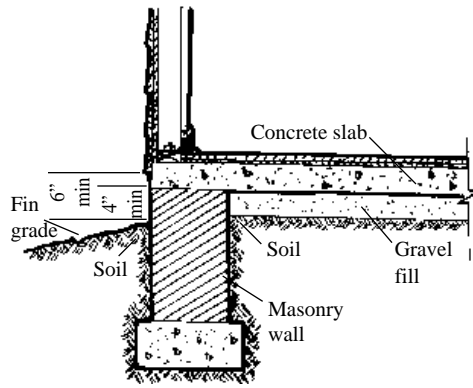

Suspended Concrete Slab-on-Ground

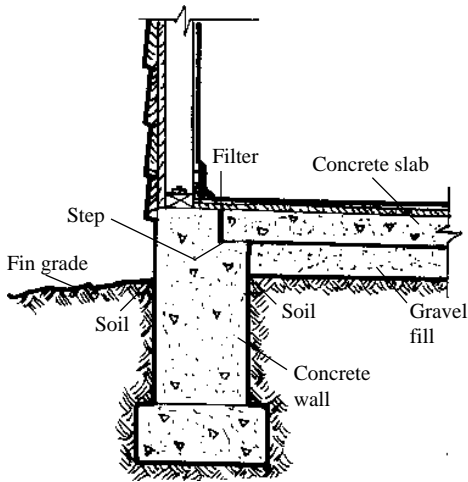

**Floating Concrete Slab-on-Ground
(Edge of slab rests on ledge of foundation wall)**

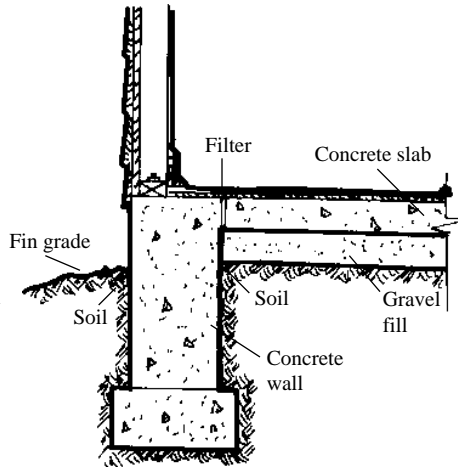

**Floating Concrete Slab-on-Ground
(Slab rests entirely on ground)**

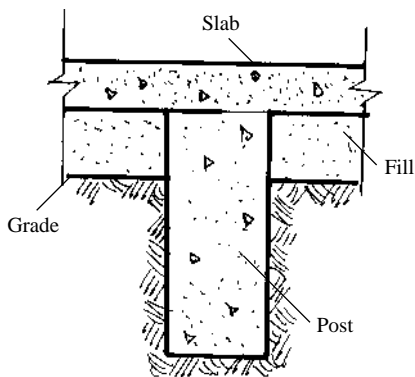

Post Hole Support of Slab

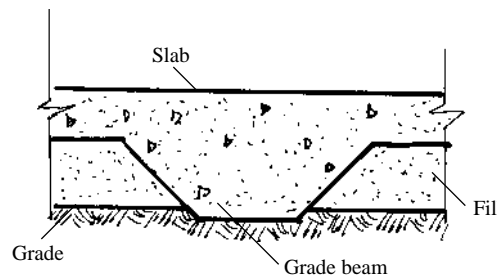

Interior Grade Beam: Often Found Under Support Walls

Soil Treatment for Subterranean Termites

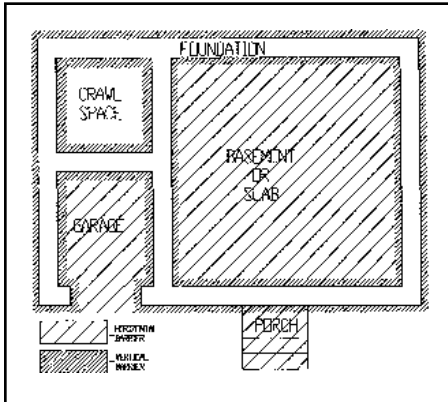

Figure 1. Pre-treatment showing vertical and horizontal barriers

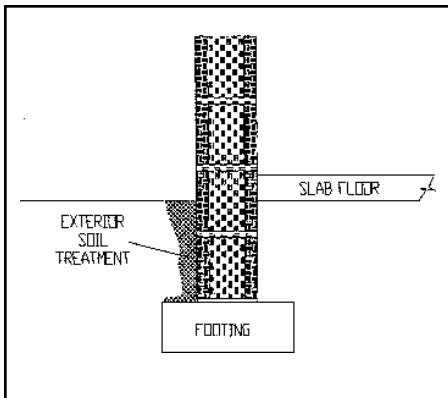

Figure 2. Exterior soil treatment

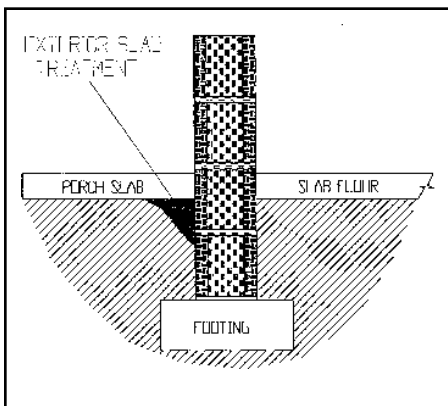

Figure 3. Exterior slab treatment

Traditionally, chemicals for soil treatment are used to establish a barrier which is lethal or repellent to termites. Disperse the chemical adequately in the soil to provide a barrier to all routes of termite entry. A thorough and uniform barrier also prevents the termites which are feeding in the structure from successfully returning to the soil for moisture which results in their death by either dehydration or contact when crossing the residual insecticide.

Effective soil treatment depends upon placing a sufficient amount of chemical to establish a barrier wherever termite entry points exist in each type of construction. The amount of chemical applied is determined by the concentration of the formulation used and the rate of application specified on the product label.

Proper uniform soil treatment prevents the need for wood treatment except where a moisture source exists above the soil level which could sustain the termite colony. In addition, wood treatment may be used as a method of accelerating the elimination of active infestations more quickly.

Preconstruction Treatment

The easiest time to apply a barrier is during construction (Figure 1). Whenever possible, pretreatment should be encouraged. The soil below all slabs should be treated before they are poured. Current regulations require treatment both under horizontal and adjacent to vertical surfaces. The concentration and rate specified on the product label must be strictly followed. It is illegal to use less than or greater than any rate or concentration specified on the label for preconstruction treatment.

Termite baiting systems also may be used as a preventive method to detect and prevent termite entry into new construction. Especially in areas where ground water contamination concerns may exist.

Post Construction Treatment

Depending on the type of construction, a treatment will include one or more of the following: (1) mechanical alteration, (2) soil treatment, (3) foundation void treatment, (4) wood treatment, and (5) baiting.

Application Procedures

Exterior Soil Treatment

Trench earth and/or rod adjacent to the foundation and treat the foundation and soil with chemical (Figure 2). Whenever possible and practical, the soil should be saturated with chemical to the footing. More often, since trenching requires hard labor, it is more practical to use a rod and vertically rod down through the soil to the footing. The chemical is applied as the rod is withdrawn. When rodding exterior soil be sure to keep rod insertion points close enough together to ensure a uniform and continuous chemical barrier.

If treatment of the exterior soil to the top of the footing is not possible or practical it will be necessary to indicate clearly to the customer that your treatment is considered either a "SPOT TREATMENT" or "LIMITED TREATMENT."

Exterior Slab Treatment

The presence of an exterior concrete slab which abuts the structure complicates this outside treatment (Figure 3). Poured slabs such as sidewalks, patios, and carports should be vertically drilled and rodded as deep as possible. It may be necessary to vary the concentration and volume, as allowed by the termiticide label, to treat thoroughly under slabs.

Treatment of Foundation Voids

Drill and treat concrete block foundation voids (Figure 4). It is very important that the holes are drilled at a height (no higher than three

Soil Treatment for Subterranean Termites

courses of blocks) such that the chemical reaches the footer. Every void should be treated in the block (4 inches to 6 inches apart). In the event of spillage, the area around all drill holes must be cleaned. After cleaning, fill all holes to prevent exposure to the occupants.

CAUTION: Special care must be taken to ensure the chemical not puddle and flow out over the inside slab floor. Should the soil line be above the interior slab line it may be necessary to trench below the slab line to safely treat block voids at a point of entry below the inside slab line.

Treatment of Brick or Stone Veneer

Drill and chemically treat brick veneer voids only where the brick ledge is below grade level (Figure 5). Holes measuring approximately $\frac{1}{4}$ inch or $\frac{3}{8}$ inch in size must be drilled from the outside into the masonry between bricks and the void chemically treated. Generally, these holes should be drilled in the masonry at a distance of no more than every other brick apart.

Introduce enough chemical to completely flood the void to the footing or base. The hole should not be drilled above the top of the foundation for basements, or the level of the interior slab in slab construction unless the slab is at exterior grade level or lower. Use enough pressure to spread the chemical and completely cover the voids. Holes drilled in outside brick walls should be sealed after treatment.

Where it is not possible to drill and treat below the top of the foundation or interior slab level it may be necessary to trench and treat the soil to below the brick ledge. This method will eliminate the need to drill and treat the void and also reduce the risk of accidental spillage into the interior of the structure.

Interior Treatment Methods

Soil treatment of the inside perimeter of a slab adjacent to the foundation can be accomplished by any one of 3 methods (1) vertical drilling, (2) short rodding, or (3) long rodding.

Vertical Drilling

This is the most common method of treatment of slab construction (Figure 6). Vertically drill through the slab floor adjacent to the perimeter foundation no more than 18 inches apart. Inject the termiticide under low pressure so it will overlap in the soil between holes adjacent to foundation.

In addition, treatment should be made adjacent to each support wall and wood partition within the structure. In the case of a masonry support foundation which extends through the floor resting on a footing, it is necessary to drill and treat soil adjacent to both sides of the wall as well as the foundation voids to prevent termite entry. Clean up the drill dust as you proceed. After treatment, be sure that the holes are closed and that the surface is finished in a manner the customer has previously agreed upon.

CAUTION: Special care before beginning treatment, due to the potential for damage, injury or contamination, must be taken to identify the location of any heating ducts, water lines or electrical conduits which are embedded in the slab.

Short Rodding

Short rodding from the outside may be a preferred option when no access is available inside due to an obstruction like a bath tub, cabinets, or shower or when trying to avoid any drilling damage to finished floor coverings inside the perimeter of the structure. As shown in Figure 7, in order to reach the sub-slab soil area, a hole has been drilled through both sides of the concrete block into the area precisely below the expansion

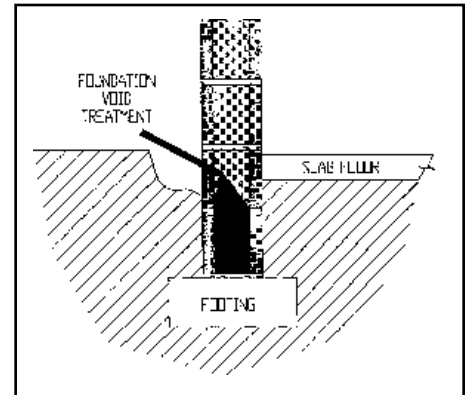

Figure 4. Foundation void treatment

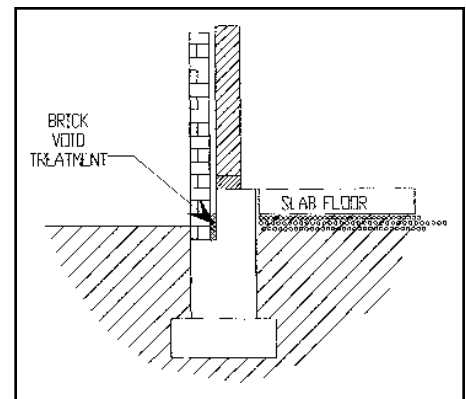

Figure 5. Treatment of brick or stone veneer

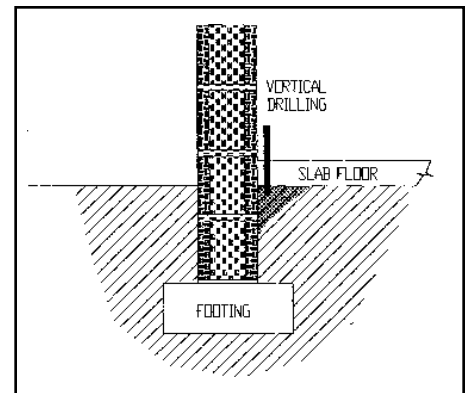

Figure 6. Vertical drilling

Soil Treatment for Subterranean Termites

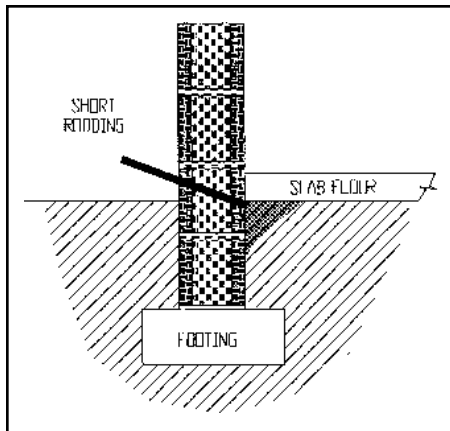

Figure 7. Short rodding

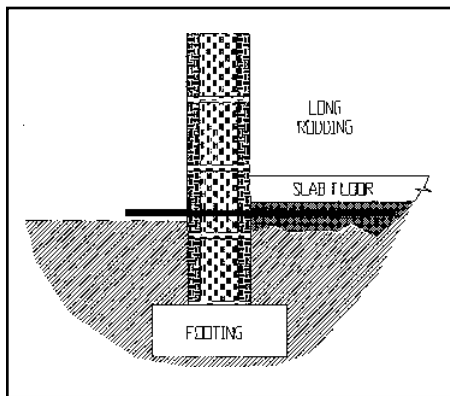

Figure 8. Long rodding

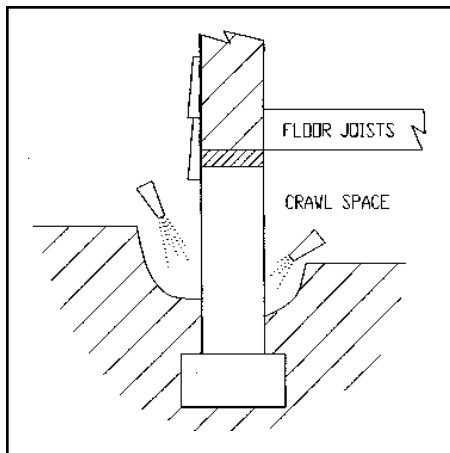

Figure 9. Crawl space treatment

joint at the edge of the slab. The rod is then inserted and chemical is applied under low pressure in order to thoroughly saturate the expansion joint area, overlapping between holes which are approximately 18 inches apart and saturating as much of the inside concrete block face as possible.

In order to do short rodding under the slab, it is necessary to accurately locate the bottom of the slab. Treatment applied a few inches too high or too low may not enable you to apply chemical without leaving untreated areas that would allow termite entry.

Long Rodding

Long rodding horizontally through the exterior foundation just below the slab level and sliding a treatment rod under the slab adjacent to the foundation is another method of treatment for slab construction where easy access to the bottom of the interior slab can be obtained (Figure 8). As in short rodding it is necessary to determine the precise location of the bottom of the slab in order to ensure no untreated soil layer remains above the treatment zone, and to allow for easier insertion of the rod for the length of the treatment to be achieved. This method has similar benefits to the short rod method with the added advantage of possible access behind concrete porches. However, long rodding for any significant distance may leave untreated areas as the rod may veer away from the foundation or down in the soil.

Soil Treatment—Crawl Space Construction

All wooden trash and debris must be removed from the crawl space. These measures will aid in proper treatment, reduce chances of future attack and aid in future inspections. Treat the soil adjacent to both sides of foundations and support walls and around piers, plumbing lines or other points of access by trenching and/or rodding (Figure 9). If the foundations or piers have hollow voids these areas must also be treated to prevent

access of termites through a crack in the footing. The soil beneath exterior porches next to the foundation should be treated by vertical drilling, horizontal rodding, or excavation to gain access for treatment.

Soil Treatment of Slab Construction with Concrete Block Foundation and Walls with Floating Slab

Termite Entry Points

Typical termite entry points are marked (Figure 10). In this type of construction there are three major entry points for the termites. Termites may come from the sub-slab area, up through the expansion joint at the edge of the slab and into the furred wall as shown, and up through a crack in the floor beneath a wood partition. They may proceed up this space to feed on door jambs, window frames, and even roof construction.

Termites can gain access into the concrete block voids and travel upwards into the same areas. This allows them access to nearly all of the wood structural members in the house, as well as any framing and molding.

Another less common method of termite entry is from the outside soil, up over the surface, into a crack or void in the masonry, and upwards through the concrete block voids or directly over into the furred wall. This occurs more frequently when there is an attached outside slab such as a sidewalk or carport which abuts the exterior structure leaving an expansion joint as well as a protected cover for termite activity.

Treatment procedures:

- Trench and/or rod exterior soil.
- Drill and treat beneath exterior slabs adjacent to foundation.
- Treat interior foundation walls by vertical drilling, short rodding, and/or long rodding.
- Vertically drill and treat adjacent to interior walls and partitions.

Soil Treatment for Subterranean Termites

- Drill and treat foundation voids.
- Wood treat accessible termite galleries.
- Repair all drilling.

Completion

This composite diagram (Figure 11) shows the total protection to the structure by thoroughly treating (1) the voids in the concrete block, (2) the soil in the sub-slab area at the expansion joint, (3) the soil around the outside perimeter of the building, and (4) the wood treated whenever there is an indicated need.

Concrete Foundation with Brick Veneer on Wood Frame Construction

Termite Entry Points

Typical termite entry points are marked (Figure 12). The solid concrete foundation eliminates some of the voids that commonly permit termite entry, but termites frequently will penetrate up through the slab expansion joint. They also will move from the outside soil area, through the brick veneer, into the void space, and directly into the wood framing.

Less commonly, termites may build tubes up over the exterior brick veneer surface, finding openings through the masonry and gaining access to the void space and wood structural members.

Treatment procedures:

- Trench and/or rod exterior soil.
- Drill and treat beneath exterior slabs adjacent to foundation.
- Treat interior foundation walls by vertical drilling, and/or long rodding.
- Vertically drill and treat adjacent to interior walls and partitions.
- Drill and treat brick veneer voids.
- Wood treat accessible termite galleries.
- Repair all drilling.

Completion

This composite diagram (Figure 13) shows the total protection afforded to the structure by thoroughly treating (1) the voids in the brick veneer, (2) the sub-slab soil area along the expansion joint, and (3) the

soil around the outside perimeter of the building to a point lower than the bottom of the veneer.

Monolithic Slab with Tile or Terrazzo Finished Floor

Termite Entry Points

The arrows indicate the very few possible entry points for termites under a perfectly formed monolithic slab (Figure 14). The figure shows how termites might enter up the outside wall and into the brick veneer, particularly if the brick veneer extends down below the soil line. With concrete block construction, termites have to come up over the solid foundation and into the block masonry to gain access to the house.

Therefore, these areas are not the main source of problems in monolithic slabs. These problems are entirely limited to the openings for pipes, plumbing, soil line, etc., and any faults or cracks, grading stakes or other embedded articles termites might use to gain access through the slab. Void treatment is not necessary unless there is a veneer of brick, stone, or stucco that extends below grade.

Treatment procedures:

- Trench and treat exterior soil.
- Drill and treat beneath exterior slabs adjacent to foundation.
- Vertically drill and treat adjacent to interior partition walls.
- Drill and treat brick veneer or foundation voids where they extend below outside soil.
- Wood treat accessible termite galleries.
- Repair all drilling.

Completion

This composite diagram (Figure 15) shows the total protection afforded the structure by thoroughly treating (1) the soil around the exterior perimeter of the building to a point lower than the bottom of the veneer, (2) the soil beneath interior wood partition walls, and (3) foundation voids if they extend below exterior grade level.

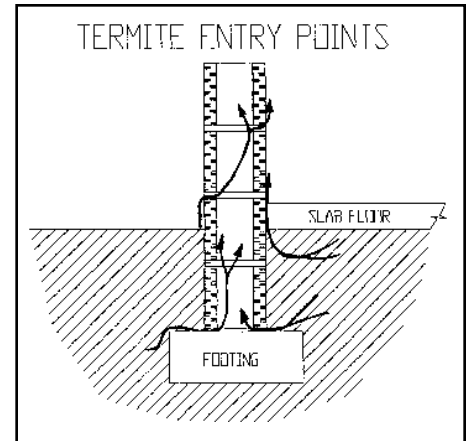

Figure 10. Block foundation entry

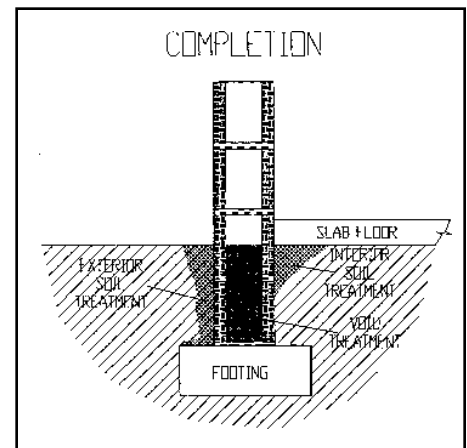

Figure 11. Block foundation treatment

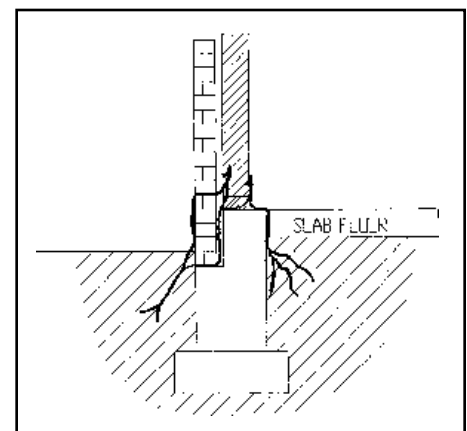

Figure 12. Concrete foundation entry

Soil Treatment for Subterranean Termites

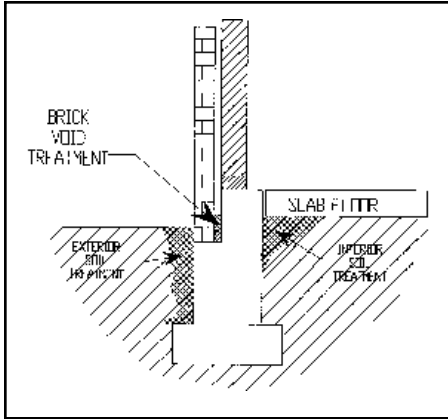

Figure 13. Concrete foundation treatment

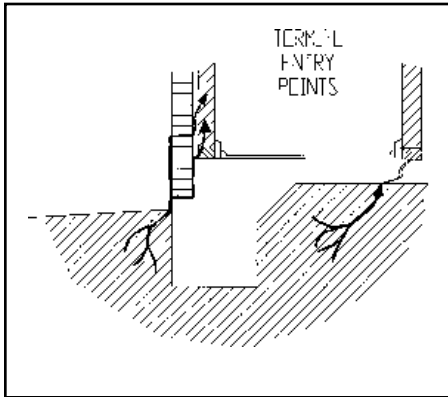

Figure 14. Monolithic slab entry

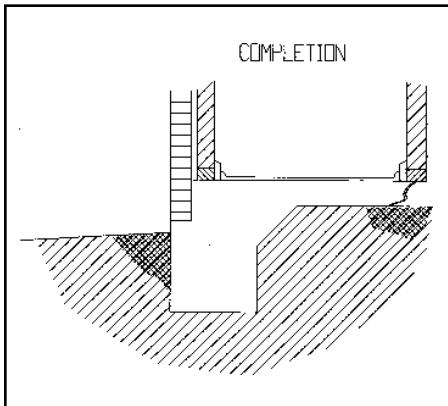

Figure 15. Monolithic slab treatment

Special Considerations

Soil treating next to the interior perimeter of the foundation, which is required in almost all other types of construction, may not be necessary in this case. However, soil treatment around the exterior is very important, particularly if there are veneers (such as brick) near the soil line. Trenching and treating is the most practical method. Remember to treat any backfill with chemical.

Rodding does not need to be done since there is no advantage here in deep soil treatment with chemical.

Wood treatment also is not required unless there is a reason for doing so. No routine treatment of wood is done in monolithic slab construction.

When drilling and rodding, use caution around sewer pipes, heating ducts, plumbing, plenums, electrical wiring, etc.

Therefore, on monolithic slabs a very careful inspection needs to be made to determine exactly how termites have gained access and to find those areas where they might gain access. The construction of access plates, doors and panels to permit inspection of the entry points of plumbing, bath traps, conduits, etc., constitutes the major part of treatment to this type of structure, together with soil treatment around the outside perimeter.

Basement Construction

Termite Entry Points

Typical entry points to basements are marked (Figure 16). These will be the same as in a floating slab construction.

Treatment procedures:

- Trench and/or rod exterior soil.
- Drill and treat beneath exterior slabs adjacent to foundation.
- Treat adjacent to interior foundation walls by vertical drilling.
- Vertically drill and treat adjacent to interior partition walls.
- Drill and treat any brick veneer voids.

- Drill and treat any foundation voids.
- Wood treat accessible termite galleries.
- Repair all drilling.

Completion

The composite diagram (Figure 17) shows the total protection afforded by completion of the following treatment procedures.

Special Considerations

The soil treatment techniques for basements are the same as described for floating slab construction on the exterior and interior of the structure. If treatment of the exterior soil to the top of the footing is not possible or practical it will be necessary to indicate clearly to the customer that your treatment is considered either a "SPOT TREATMENT" or "LIMITED TREATMENT." Brick and stone veneer should be drilled and treated only if they extend below grade level, and then treatment should only be made below the top of the foundation wall to prevent accidental contamination of the interior. Hollow foundation treatment should be made from the interior in the case of unfinished walls, and then only at the bottom course of block just above basement floor level. In the case of a block, rubble, or other masonry foundation wall with interior finished walls, use extreme caution in treating exterior soil and voids in the foundation as seepage of termiticide may occur during treatment resulting in contamination.

Retreatments for Soil Applied Termiticides

Routine or annual retreatments should never be made. Retreatments are generally made only if there is evidence of reinfestation, if the initial treatment was inadequate, or if the chemical barrier has been broken by moving soil around the structure. The retreatment is normally a partial treatment in the areas of infestation or soil disturbance and should be recorded as a partial or spot treatment on the statement of services.

Soil Treatment for Subterranean Termites

Wood Over Slab

To treat the soil under a slab covered by a wood floor, both the wood and the slab should be drilled and treated in a checkerboard pattern

to ensure adequate coverage. The wooden floor also may be removed to facilitate treatment. After treatment, all holes in both the slab and wood floor must be filled.

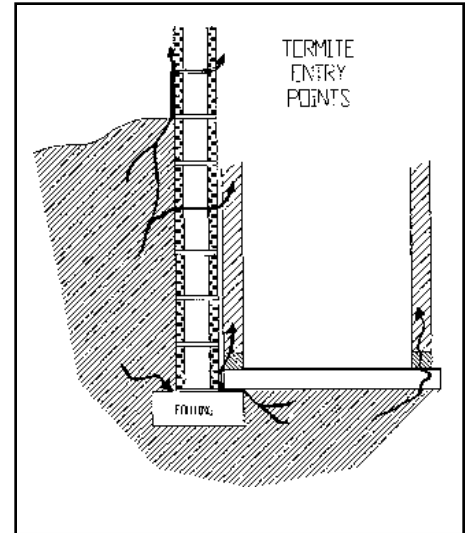

Figure 16. Basement entry

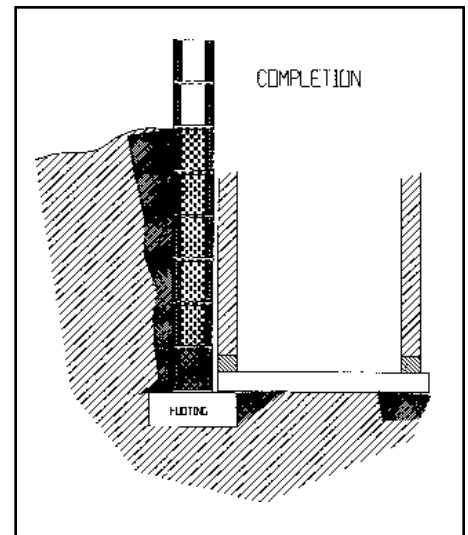



Figure 17. Basement treatment

Soil Treatment for Subterranean Termites

Questions

1. (22) The easiest time to apply a barrier treatment for termite control is:
 - a. April to June
 - b. during construction
 - c. when water is around the footings
 - d. August to October
2. (22) In treating block foundation voids, treat _____.
 - a. every void
 - b. every other void
 - c. every third void
 - d. every fourth void
3. (23) Drill and treat brick or stone veneer only when the brick ledge is:
 - a. 2 feet above grade
 - b. 1½ feet above grade
 - c. 1 foot above grade
 - d. below grade
4. (23) An option to vertical drilling of interior slab construction is:
 - a. direct wood treatment
 - b. trenching
 - c. short rodding from outside
 - d. sub-slab fumigation
5. (24) Long rodding has similar advantages to _____ for treating under interior slab construction.
 - a. short rodding
 - b. vertical drilling
 - c. sub-slab fumigation
 - d. trenching
6. (24) Post construction treatment of crawl space should include treating the foundation, around piers, support walls, and _____.
 - a. floor joists
 - b. sill plates
 - c. plumbing lines
 - d. wall studs
7. (25) Almost all kinds of construction require interior perimeter treating of the foundation except:
 - a. monolithic slab
 - b. block foundation with floating slab
 - c. basement construction
 - d. crawl space
8. (26) Typical termite entry points for basement construction are the same as for _____.
 - a. monolithic slab
 - b. floating slab
 - c. crawl space
 - d. plenum
9. (26) Routine soil retreatments for termite control should:
 - a. never be made
 - b. be applied every 2 years
 - c. be applied every 3 years
 - d. be applied every 4 years

Avoiding Contamination



In recent years, concerns for the presence of termiticide residues and vapors in structures chemically treated for termites have been growing. Complaints that previously were dismissed as odor problems may now be serious "contamination" complaints. In some cases, residues and chemical vapors are caused by accidents, carelessness, misapplications or inattention to details of the structure being treated. The pest control operator might even apply the termiticide completely in accordance with the label directions and still be the defendant in a civil action. The issues involved in termiticide residues are very complex, so it is vitally important that the applicator take every step possible to minimize structural contamination. Risk benefit analysis is crucial in order to determine which termiticide or termiticides to use and how or if a structure may be treated.

The importance of avoiding any form of structural contamination was brought to the attention of the pest control industry, regulatory officials and the general public as the result of a 1982 report from the National Academy of Science (NAS). The Academy set forth interim guidelines for long-term airborne termiticide exposure. Those guidelines were intended to serve until more research could be completed and some standard levels of exposure established. They do not represent a known level at which adverse health effects are caused in humans. The only standards that exist at this time are those established by the American Conference of Governmental Industrial Hygienists and the Occupational Safety and Health Administration (OSHA). Those standards are set for exposure of persons in the work place.

The primary route for human exposure in structures is inhalation. Young children, older people and persons that are not in good health

are, in general, more susceptible to adverse health reactions due to exposure to pesticides. The safety of any chemical is dependent on its toxicity and the degree of exposure.

For a short time following a termite treatment, the level of termiticide residue in the air may exceed the NAS guidelines but is usually below the OSHA standards. Within a few weeks the levels usually are within the NAS guidelines.

Termiticides themselves have little odor. The odor immediately after treatment is a result of the solvents used in the formulations. Later, the odors may be due to the active ingredients of the termiticides in the air of the living area of the structure. Airborne termiticide residues are generally higher in damp, poorly ventilated areas. Materials will hold volatile chemicals more strongly when dry than when they are moist. Termiticide emulsions are absorbed by concrete, brick, plaster, unpainted wood and other absorbent structural materials.

Training in proper inspection techniques is important in the prevention of contaminating air and water. Accurate measurements of both the interior and exterior are important in preventing termiticide residues. An adequate inspection and description of the structure should be made, including any structural defects, the proximity of any wells or cisterns, the kind of heating system and location of vents, and the location of any underground utility lines, including water lines to outdoor swimming pools, wells or cisterns. Other factors that may affect the treatment or the potential for risk should be noted, such as the history of the building, and if several additions have been made. When planning treatment of structures that contain sub-slab heating or unique structural elements, blueprints can be extremely helpful but may not be reliable.

It may be necessary to alter the structure or make repairs before treatment is performed. Many of the

Avoiding Contamination

potential points of termite entry noted in this manual also are potential points of entry for termiticides into the living area of the home. Termiticide may flow through voids, expansion joints or cracks in slabs and foundation walls. Termiticide flowing up through adjacent drill holes is another possible source of contamination.

Successful termite control usually can be achieved without undue risk to the building's occupants. It may occasionally be necessary to perform a less than complete treatment to avoid structural contamination. If a partial or spot treatment is performed, the diagram accompanying the statement of services must show the area or areas of the structure which were treated, and the contract must indicate that the treatment was not complete.

Equipment should be maintained so hoses, gaskets or injector tools will not break or leak. When filling the tank, use of anti-backflow devices on hoses is required. Use nozzles that are designed to prevent splash-back of the termiticide during application. When it is necessary to bring hoses into a home, be sure that the hose is as clean as possible. Plastic sheets or some other protective material could be used under the hose to protect the floor covering from contamination. Carpeting should be pulled back from the areas where termiticide is injected below the slab. It is recommended that electric safety shutoff devices and depth gauges be used to reduce the risk of damage when drilling slabs in structures that may contain sub-slab or in-slab duct work, radiant heating or sub-slab utility lines.

When arriving at a house to do a post construction application, the diagram of the structure should be reviewed to assure that it is correct, and any alterations that have been made since the diagram was drawn should be noted. Do not begin treatment until all duct work and utility lines have been located. Duct

work should be inspected to ensure if it is properly intact and sealed.

Lowering the pressure at the pump to the lowest possible p.s.i. to get the job done in a reasonable amount of time will aid in preventing indoor air contamination and potential contamination of groundwater. In some cases where there is a high water table, gravity flow may be the only means available to treat soils beneath exterior slabs.

Do not treat soils that are water saturated or frozen anywhere in the soil profile. Treating such soils may result in the termiticide traveling in groundwater contamination. Soils adjacent to occupied structures are generally warmer in the winter than the surrounding soils. Applications may be made when the air temperature is below freezing, as long as the soil has not yet frozen. Remember that once the soil has frozen, it may take a long time for it to completely thaw, even though the soil surface has thawed to a couple of inches in depth.

Soils are saturated when about 95 percent of the total air space is filled with water. The remaining 5 percent is filled with trapped air. It is difficult to determine when the soil adjacent to the structure is saturated. This is complicated by the presence or absence of footing drainage tiles and, in many cases, the fill around the structure is often a combination of clay subsoil, sand, gravel and building debris. It is important that none of the soils in the profile from surface to footings, around the structure are saturated. The chemical barrier will not be complete when a termiticide is injected into a layer of saturated clay. Soil saturation can be determined by observing free water in an unlined auger hole adjacent to the structure. Remember that each side of a structure may have different fill material and receives and retains differing amounts of precipitation so when saturated soil is in question it may be necessary to make several auger holes around the structure for observation.

Avoiding Contamination

Should a Spill Occur

1. Turn off the pump immediately.
2. Contain the spill to keep it from spreading.
3. Absorb the spillage and collect any contaminated containment material.
4. Remove the contaminated materials.
5. Dispose of in a safe and legal manner.

Specific information on dealing with termiticide spills and residues may be obtained from the termiticide manufacturer or the Kansas Department of Health and Environment (913-296-1679).

Special Tools and Techniques

In the past, sub-slab treatment relied only on the theory that termiticide application points would create overlapping puddles which would establish a continuous treatment barrier. Uneven grade levels, sloping grade away from the foundation walls, or physical obstructions can result in failure to achieve proper soil treatment barriers under slabs.

Recently, there has been the development of tools and techniques to enhance the ability to achieve a thorough and uniform chemical barrier. Two of these developments are termiticide foam generating machines, and directional or lateral dispersion treatment tips.

Termiticide foam

Where hollow areas under slabs are suspected of providing termites the opportunity to tunnel across the bottom of the slab, a termiticide foam generating machine may be used to enhance the treatment barrier.

Treat the soil under the slab first to establish the soil barrier then inject the termiticide foam to fill the void under the slab. This will coat any termite tubes on the underside of the slab. It is important to first make the proper soil treatment application at the prescribed label rate and then follow with the foam since the diluted termiticide combined with the foaming agent and air will reduce the amount of active ingredient being applied to the void. Additionally, once the void is filled with foam it may not be possible to inject the liquid dilution to the soil.

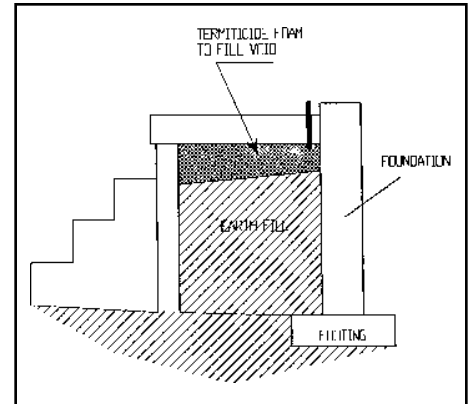

Termiticide foam

Directional tips

Treatment tips of varying styles can be used to direct the termiticide under the slab in a manner that assures treatment is achieved in the areas intended. When vertically drilling and using a horizontal directional tip, it is necessary to determine the thickness of the slab prior to treatment so application can be made between the base of the slab and the soil fill below. Be sure the tip is directed toward the location of the desired treatment barrier, such as foundation wall, partition wall, crack in floor, plumbing line, or other object which extends through the slab which would provide an access point for termites.

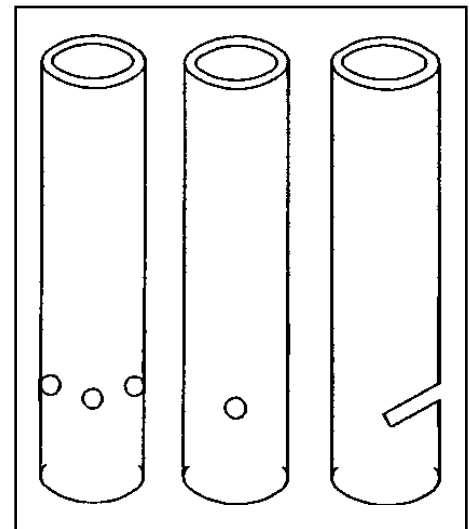

Directional tips

Avoiding Contamination

Questions

1. (29) Chemical contamination can result from which of the following:
 - a. accidents
 - b. carelessness
 - c. misapplication
 - d. all the above
2. (29) The primary route of human exposure to pesticides in structures is
 - a. inhalation (breathing)
 - b. dermal (skin)
 - c. oral (mouth)
 - d. ocular (eyes)
3. (29) To help prevent structural pesticide contamination, a proper inspection includes
 - a. structural defects
 - b. proximity to wells and cisterns
 - c. kind of heating system
 - d. all the above
4. (30) Termiticides contaminate homes by flow through
 - a. voids
 - b. expansion joints
 - c. cracks in slabs and foundations
 - d. all the above
5. (31) Should a spill occur, the first action to take is to:
 - a. turn off the pump
 - b. contain the spill
 - c. absorb the spillage
 - d. remove the contaminated material
6. (31) Two recent developments to get uniform coverage in sub-slab treatments are termiticide foams and _____.
 - a. drilling more holes
 - b. directional tips
 - c. applications at $3 \times$ the label rate
 - d. making two application, 3 months apart



Problem Treatments

If a structure or an area is identified as having the potential for a problem in treatment, it is advisable to have one person inside while another performs exterior treatment of the soil, brick veneer, hollow block or rubble foundations. In some structures it will be necessary to drill, treat and plug one hole at a time to prevent contamination of the slab by the termiticide flowing out of unplugged drill holes.

Crawl spaces

Soil treatment with most termiticides should not be done in structures which use crawl spaces as hot or cold air plenums. Check the label carefully to determine if plenums may be treated. A plenum is any area that circulates air from the crawl area throughout the structure without ducts. In non-plenum structures, air ducts in the crawl area should be examined before treatment. If breaks or leaks at joints are found, they should be repaired before treatment is made. Some air handling units are located in crawl spaces and draw air from the crawl area. It is recommended that they should be ducted to draw in air from outside of the structure prior to treatment. It also is recommended that all crawl areas have adequate ventilation to prevent the build-up of odor and airborne termiticide residues. If it appears that odor will be a problem, in addition to covering the treated areas with untreated soil, covering the area with anchored vinyl sheeting is recommended.

Access should be made when structures have inaccessible crawl areas within the foundation. Visually inspect in order to determine the best method of treatment. If there is sufficient clearance, treatment should proceed as in any other crawl area. If there is insufficient clearance between the floor joists and the soil, remove sufficient soil for access and

treat. It also may be acceptable to drill the floor and treat by rodding. The area may also be treated by horizontal drilling and rodding. Vent the area, if possible.

Slabs containing or covering heating ducts

Special care should be taken in soil treatment of buildings that contain these structural elements. Inspect the ducts as much as possible using a mirror and flashlight. If it appears that they are made of cellulose containing material or have soil or sand bottoms, standing water, or appear not to be properly sealed, reconsider treatment. Such ducts should be sealed with concrete and an alternative air handling system installed before soil treatment. An aid to locating ducts in slabs is to turn on the heating system and place damp newspapers over the suspected area where the ducts are located. The newspapers will begin drying in the areas immediately over the duct work.

After drilling is completed, but before treatment, close off all vents. Turn on the fan for the air system. Check each hole for air flow. If air flow is detected, plug the hole(s) and do not treat them.

Following treatment, if odor of the termiticide is detected, contact the termiticide manufacturer for instructions on dealing with residue removal.

Basements

Before treating, inspect the foundation walls for cracks where seepage of termiticide may occur when the soil outside is treated. If cracks or void areas are present in the foundation wall or if inspection cannot be made, a second staff member should be in the basement to watch for any leakage through the wall while the soil outside is being treated. It also is recommended to check the basement wall when treating in the areas of the front and back stoops, to assure that the termiticide does not seep over the sill plate. If the basement has an

Special Treatments

exposed soil floor, cover the treated area with 2 to 4 inches of untreated soil or other impervious barrier after treatment is completed.

French drains can be a problem. French drains are used to drain water into a sump, storm sewer or other area. They usually are found around the perimeter of a finished basement. You may want to drill test holes before proceeding with treatment. If a sump pump is present, turn it off and inspect the sump. If water is present, remove some. Observe the water level for 15 minutes. If the level of the water rises, delay treatment until a time when the soil is drier. Also observe the sump during the course of treatment for the presence of termiticide. If termiticide is present, remove the contaminated water and dispose of it in a safe and legal manner.

Veneers

Brick, artificial stone and other veneers which extend below the exterior grade must be treated. Drill below the top of the foundation wall and use low pressure or trench and treat exterior soil to below the brick ledge.

Hollow block, tile and rubble foundations

Sometimes termiticide will leak through these types of construction materials or vapor will escape from the uncapped top of hollow blocks causing residue problems. If the potential for this problem is encountered, ensure that all cracks and openings are sealed. If the mortar joints of rubble walls are in poor condition, the wall should be sealed with concrete. Low pressure or gravity should be used whenever treating the voids.

Wells, cisterns and other water sources

Do not treat the soil beneath structures that contain wells, cisterns or springs within the foundation walls. Unused wells on the property

should be filled, not just capped. The closer a water source is to the foundation, the greater potential for contamination. In very dry weather, termiticides can move considerable distances along cracks and fissures in the soil. They also can move through small void areas that exist between the soil, pipes and casings. Swimming pools also might be contaminated in the same manner. Sandy soils lessen the potential for these problems. Treat with extreme care adjacent to walls through which any water lines run. If the well is extremely close to the foundation, consider not treating that wall (with the written permission and understanding of the owner). When wells are in the vicinity, be sure to check with the local authorities to be sure to comply with any special distance requirements.

A good general practice of treating soil next to foundation walls near wells and cisterns is to remove the soil from grade to the footing and place it on vinyl sheeting. Treat this soil outside of the foundation and let it dry thoroughly. It may be appropriate to line the trench with plastic sheeting. Return the treated soil to the trench.

If the soil around the water pipe is to be treated, remove the soil completely from around the pipe and treat as above. Be sure that the treated backfill is completely dry before replacing it in the trench.

Alternative treatments to consider when well water contamination is a concern include the use of borate wood treatments and/or the use of termite baiting systems.

Rigid Foam Insulation Board

Building techniques that use foam insulation in direct contact with the soil can make termite protection by soil treatment virtually impossible.

Building methods using insulation that cause a problem for soil treatment include:

1. Insulation forms between which concrete foundations are poured.

Special Treatments

2. Rigid board foam insulation extending below grade level.
3. Foam filled concrete blocks.

Termites do not eat the foam but tunnel through the insulation to access wood in the structure. This allows them to avoid contact with soil treatment barriers.

Termite infestations in foam insulation board often are not visible during an inspection. It is advisable to have the property owner remove outside foam to 6 inches above and below grade level to allow for proper treatment and future inspection. For crawl spaces, remove the insulation from the inside foundations in the same manner.

Control may be achieved by trenching and treating soil and backfill where insulation board has been removed to below grade. As shown in the diagram, this will create a soil barrier that interrupts termite access through the insulation.

Soil treatment will not prevent termite entry in structures that contain foam filled hollow block foundations since voids cannot be properly treated. Termites can enter through a crack in the footing in this type of construction.

The development of termite baiting technology has provided a possible solution to the problems associated with "in ground" foam insulation since achieving a complete and uniform chemical barrier can be difficult if not virtually impossible. Baiting technology would allow direct treatment of the termite colony without regard to the many termite entry points into structures containing foam insulation.

Wood Treatment

Since the advent of soil treatment for termites there has been little need for extensive wood treatment of structures, however, conditions may exist in certain structures that can reduce or even prevent the opportunity of making a soil application of termiticide. In these cases, consider the following wood treatment

techniques to provide some protection from termite attack.

Borates

The application of Borates in a water-based dilution to wooden structural components will allow absorption into the wood fibers. This will prevent termite attack to the treated wood. Because borates are stomach poisons and must be ingested by the termites in order to be effective, they will not prevent termites from tubing across treated wood to reach untreated portions of the structure. They generally do not possess any contact residual effect. Borates also are highly soluble in water and can leach out of treated wood after applications have been made.

Wood Injection

Direct injection of residual insecticides into termite galleries in the form of pressurized (aerosol) or liquid emulsions can be made where termites are actively feeding in wood portions of the structure. The termiticide will bond with soil particles in the termite galleries just as they do in soil to provide some extended residual. Wood treatment with contact residual insecticides to wood surfaces will provide some short term barrier effect but will not provide extended prevention as does application of insecticide to the soil. It also may be possible to inject aerosol insecticides directly into wood on a limited basis by drilling and injecting into wooden structural components. However, it is difficult to achieve complete saturation of all the wood to prevent termite attack.

Wood treatment is most commonly used as a supplement to either a soil treatment or termite baiting system application because of the difficulty in treating all wooden components. They are, however, an available means of providing limited control in situations where soil treatment due to ground water contamination or sub-slab heating duct contamination concerns exist.

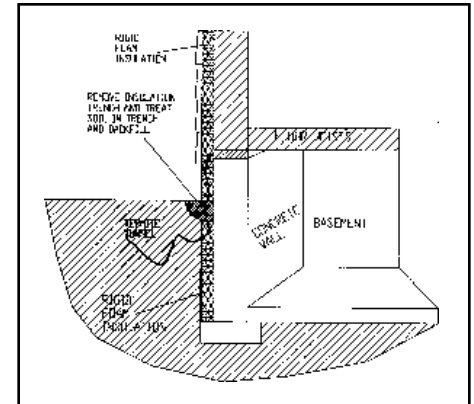

Rigid Foam Treatment

Special Treatments

Questions

1. (33) Soil treatment with most termiticides should NOT be done
 - a. as a sub-slab injection
 - b. in a crawl space used as a plenum
 - c. under a hollow block foundation
 - d. under a poured foundation
2. (33) When treating slabs containing or covering heating ducts, you should reconsider treating if the ducts:
 - a. are made of cellulose containing material
 - b. have soil or sand bottoms
 - c. have standing water
 - d. all the above
3. (33) Before treating a basement on the outside,
 - a. turn all electric outlets off
 - b. fill the sump (if present) with water
 - c. check foundation walls for cracks
 - d. close all doors and windows
4. (34) Veneers which extend below the exterior grade, the soil must be treated to a depth
 - a. of 3 inches
 - b. of 12 inches
 - c. of below the brick ledge
 - d. of the footings
5. (34) A good general practice of treating near foundation walls near wells or cisterns is to:
 - a. trench only
 - b. short rod only
 - c. remove the soil to the footings and treat it than replace it.
 - d. treat the soil surface with a light spray and cover with bark chips.
6. (35) Rigid foam board insulation below grade
 - a. repels termites 100%
 - b. allows termites to avoid soil treatment barriers
 - c. provides a good food source for termites
 - d. is never a factor in termite control



The use of baiting materials for termite control is being rapidly developed. The concept is not new, it has been studied for several years. As the understanding of termite biology and behavior grows, products and delivery systems are being developed to administer slow acting toxicants to the termites. The products presently available may; (a) only control termites in a localized area; (b) suppress the colony or; (c) control the entire colony by total elimination. To be successful, the products must be readily consumed by termites, non-repellent, and slow acting.

The timeframe for control may be from a few months to many months. The control period depends on such factors as: the product selected; application timing; the time to “discovery” by the termites; the amount of feeding; colony size; and whether or not termites are present. The timeframe will be impacted by the utilization of other control measures.

These products will fit into an Integrated Pest Management (IPM) termite control program. The elimination of conditions conducive to termite infestation, judicious use of liquid soil products either as a spot or limited barrier application, and use of wood treatment products in conjunction with the baiting materials will comprise the IPM termite control program. This program will require more frequent visits to the site to provide ongoing service and monitoring of the control program status.

Types of Termite Baits

There are currently three types of bait products available. The types are:

1. Ingested Toxicants
2. Biotermiticides or “Microbes”
3. Insect Growth Regulators (IGRs)

Each bait type offers unique features and will be used differently in termite control programs. Ingested toxicants will offer the quickest

response. However, dose-dependency and learned avoidance may limit this type of product to termite reduction in localized areas.

The “biotermiticide” which is derived from fungi, bacteria, or nematodes, is injected into active gallery sites. The biotermiticide then develops on the infected foraging termites and is spread among the colony. Suitable environmental conditions (temperature and moisture), early detection and avoidance will determine the success of this treatment. It may provide localized area control or, with optimum conditions, may provide colony suppression.

The IGRs offer a variety of delivery systems and control measures. The products in this category include juvenile hormone analogs (JHA), juvenile hormone mimics (JHM), or chitin synthesis inhibitors (CSI). These products disrupt the termites by exhibiting a specific response or behavior within the colony or blocking the molting process. These are the slowest of the control types but have greater impact on the colony.

Commercial Baiting Products

Because the baiting technology is just coming into commercialization at the time of the revision of this manual, all products presently available are listed briefly below. Applicators are strongly encouraged to familiarize themselves with this technology and these and future products. For additional information on termiticides, refer to the section entitled, “Chemicals Applied for Termite Control.”

- Active ingredient: Hydramethylnon
Manufacturer: American Cyanamid
Mode of action: Metabolic inhibitor after ingestion

This product will be placed in and around the structure. The bait will be in stations. Station placement will intercept the termite tubes. The

Baiting

Technology

performance is related to the food used in the formulation. The food source is highly preferred by termites. The termites will forage, feed upon the stations, and then die.

- Active ingredient: Sulfluramid
Manufacturer: FMC Corporation
Mode of action: Metabolic inhibitor after ingestion

FMC Corporation has two separate systems. The “First Line¹” bait system and the Interceptor¹ bait system.

The Interceptor product is an on-the-wall application. The Interceptor¹ bait station is placed over a termite tube. The tube is broken open to allow the termites access to the bait station. The Interceptor bait station contains the sulfluramid bait. Termites feed on the bait, and die soon after.

The First Line bait system consists of baited stations placed in termite conducive areas around the structure or next to termite tubes. The termites forage to find the stations, feed on the bait, and die.

- Active ingredient: *Metarhizium anisopliae*
Manufacturer: EcoScience
Mode of action: Pathogenic fungus
BioBlast² is the tradename for EcoScience’s bait program for termite control. BioBlast is an EPA registered wettable powder containing live spores of the insect-killing fungus, *Metarhizium anisopliae*. This product is injected into the termite galleries. The spores germinate and penetrate the cuticle of the termites. The rapid

growth of the fungus inside the termite results in destruction of body tissues and death. The spores are carried around by the termites and transferred to colony mates. The spread of spores in this manner is known as “horizontal transfer.” This system will control termites in a localized area if conditions are right for the fungus to grow and prosper.

- Active ingredient: Hexaflumuron
Manufacturer: DowElanco
Mode of action: Chitin synthesis inhibitor

Sentricon³ Colony Elimination System is marketed by DowElanco. This system utilizes monitoring for termite activity, baiting to eliminate the termites, and continued monitoring to ensure the structure remains termite free. Stations are placed around the structure. Monitoring devices are placed in the stations. The stations are checked periodically for termite feeding.

Once termites feed on the monitoring devices, the monitoring devices are replaced with a bait matrix. The termites feed on the bait matrix containing the active ingredient. Termites pass the active ingredient to colony mates and die during the molting process. The feeding activity is monitored. When feeding stops, the bait matrix is removed and monitoring devices are again placed in the station. Periodic checking continues to ensure the structure remains termite free.

¹Trademark of FMC Corp.

²Trademark of EcoScience

³Trademark of DowElanco

Baiting

Technology

Questions

1. (37) Termite baiting systems presently available may
 - a. only control termites in localized areas
 - b. suppress the colony
 - c. provide total colony elimination
 - d. all the above
2. (37) To be successful, termite bait products must
 - a. be readily consumed
 - b. be non-repellent
 - c. be slow acting
 - d. all the above
3. (37) The type of termite baiting system that will likely provide localized reduction are the
 - a. ingested toxicants
 - b. biotermiticides
 - c. insect growth regulators
 - d. physical traps
4. (37) The type of termite baiting system that will likely provide colony suppression are the
 - a. ingested toxicants
 - b. biotermiticides
 - c. insect growth regulators
 - d. physical traps
5. (37) The slowest acting of the termite baiting product types are the
 - a. ingestion toxicants
 - b. biotermiticides
 - c. insect growth regulators
 - d. physical traps

Fumigation

The General Manual manual informs you of the basic required information that is common to all pesticide labels including such information as a list of active ingredients, type of pesticide, formulation, EPA registration number, hazard statement, personal protective equipment, etc. Specific information, however, varies from label to label, particularly under directions for use and recommendations for use.

Fumigants are pesticides which by themselves or in combination with any other substances, are, or become, gas or a mixture of gases. Fumigants will kill or control a pest and are usually poisonous or dangerous to humans. Various aerosol space sprays (a suspension of liquid in air) are not considered fumigants.

Fumigants penetrate cracks, crevices, and the commodity being treated. They must reach the target pests as gases to be effective. As soon as a fumigant is diffused from the target area, pest reinfestation can occur. Fumigants must be applied in enclosed areas.

Advantages of Fumigation

Fumigation has several advantages over other pest control procedures.

- Fumigants are usually quick acting and can result in eradication of the pest.
- Fumigants diffuse through all parts of the structure or commodity being treated and thus reach pest harborages that cannot be reached with conventional pest control materials or techniques.
- For certain pests/commodities, fumigation is the only practical method of pest control.

Disadvantages of Fumigation

There are several reasons why fumigation may not be the best means of pest control. These are:

- The control achieved through fumigation is temporary. There is no residual action from fumigants and as soon as the fumigation is completed, the structure or commodity fumigated is susceptible to reinfestation.
- Fumigants are toxic to humans and special precautions must be taken to protect fumigators and the occupants of fumigated structures.
- Because fumigants are gases, provision must be made to retain the fumigant within the space being fumigated. This requires additional labor.
- Fumigation must not be attempted by one person. Additional labor is required.
- Some commodities or pieces of equipment may be damaged by certain fumigants and must be either removed or protected.
- The technique of applying fumigants requires special training for all members of the fumigation crew, adding to fumigation costs.
- Fumigation usually requires that occupants of the structure vacate the building for a number of hours. This may be inconvenient.

Pests Considered for Fumigation

- Drywood termites. Usually imported in furniture.
- Anobiid powderpost beetles. Usually in soft woods (floor joists, etc.).
- Lyctus powderpost beetles. Attack sapwood of hard woods (tool handles, flooring, etc.).
- Old house borer. Attack sapwood of soft wood (beams, rafters, etc.).

Selection of Fumigants

When choosing a fumigant, the following kinds of factors should be considered:

- label approval for intended use.
- toxicity to the target pest.
- volatility and ability to penetrate.

- corrosive, flammability and explosive potential.
- warning properties and detection methods.
- effect on seed germination or finished product quality.
- residue tolerances.
- availability.
- ease of application.
- cost.

Several factors can change the efficiency of fumigants. Consider these when selecting a formulation and dosage:

Temperature—The fumigant may not kill the pests if the product or space being fumigated is below 10°C (50°F) or above 46°C (115°F).

Moisture—As the moisture content increases, it becomes more difficult for a fumigant to penetrate. This also increase the potential for residues exceeding legal tolerances. Adequate moisture is required for the generation of some fumigants.

Pests—Susceptibility to fumigants depends on species, habitat, and stage development. During some stages of their life cycle, for example, many insects are protected by the product they infest.

Structure—Consider the condition of the structure, the type of construction, and the product it contains.

A wooden structure, even when sealed well, will not retain fumigants as well as metal, plastic, masonry, or concrete. Fumigation in vacuum chambers allows increased efficiency.

Fumigants for Wood Destroying Insects

NOTE: Fumigation requires specialized equipment and training. The following is generalized information on fumigant products. Applicators must obtain and follow all manufacturer's and label specific directions.

Methyl Bromide at a glance:

Required Clothing:

- Loose shirts, long trousers and socks that are cleaned after each wearing. Do not wear jewelry or gloves.

- Full-face shield for eye protection, when handling the liquid such as opening the cylinder to introduce gas into a structure.
<5 ppm no respiratory protection required
>5 ppm NIOSH/MSHA approved SCBA or combination air-supplied/SCBA respirator.

Uses:

What—Structures and dwellings, bags, boxes, crates (empty), furniture, lumber and wood products.

Where—Chamber and vault fumigation—vacuum chambers, tarpaulin fumigation.

Methyl Bromide (MB)

Properties:

Colorless, odorless gas which is heavier than air and readily penetrates commodities. Relatively harmless to plants and trees. Easily removed by aeration.

Fire hazard:

Nonflammable at usage level (flammable at 13.5 to 14.5 percent in air). Extinguish pilot lights and flames in building before using.

Explosion hazard:

Nonexplosive, although overdosages of methyl bromide may create an explosion hazard because the gas can expand beyond the holding capacity of the vault or tarp.

Human hazard:

Not as toxic as some other fumigants but needs caution because of lack of odor. Most suppliers add 2 percent CP as a warning agent although CP may be absorbed by commodities and fail to indicate MB presence. Liquid MB will cause severe blisters on contact with skin. Tests with a halide leak detector will indicate dangerous concentrations by a light green to dark green to blue green to blue flames. Use detector tubes or thermal conductivity apparatus for more exact determination of MB in air. Exposure brings neurological symptoms (headaches, incoordination, visual disturbances). Monthly blood bromide tests are suggested for those using or exposed to near maximum MB levels.

Fumigation

Uses:

READ THE LABEL. Not as toxic to insects as other fumigants but penetration into commodities enhances its uses. Certain commodities (iodized salt, sponge rubber, leather goods, viscose rayons, photo chemicals, etc.) should not be exposed to MB.

Aluminum Phosphide, Magnesium Phosphide [Hydrogen phosphide, PH₃, (Phosphine, Phostoxin, Fumicel, Detia, Fumitoxin, others)] at a glance:

Required clothing:

- Dry cotton gloves if contact with the pellets or tablets will be made.

Respiratory protection:

- Respiratory protection required if exposure is likely to exceed the 8-hour TWA of 0.3 ppm during application, or is above 0.3 ppm at any time after application has been made.

Levels:

0.0–0.3 ppm—No protection required.

0.3–15 ppm—NIOSH/MSHA approved full-face gas mask—hydrogen phosphide canister.

0–1500 ppm—can use the gas mask described above for escape only.

>15 ppm—or unknown level—NIOSH/MSHA approved SCBA.

Uses:

What—Raw agricultural commodities, animal feed and feed ingredients, processed food, tobacco, and certain other non-food items.

Where—Fumigation of railcars, bins, silos, under tarpaulins in small sealable structures and enclosures, mills food processing plants and warehouses.

Aluminum Phosphide (Phosphine) (PP)

Properties:

Colorless gas which may have a carbide or garlic-like odor (due to impurities present when the gas is generated). Penetration into commodities is excellent. Aeration quickly removes PP after fumigation.

Fire hazard:

Highly flammable at 1.79 percent in air (and up) which is considerably above the usage concentration. Reacts with all metals and especially copper causing severe corrosion; therefore, all wiring, motors, switches and other equipment must be protected.

Human hazard:

Highly toxic to man with the lowest threshold working limit of 0.3 ppm (.00003 percent air). Garlic odor warns of toxic concentrations but may not always be present when PP is above 0.3 ppm. Detector tubes should be used to ensure safe working levels for employees. Symptoms include fatigue, buzzing in ears, nausea, pressure in chest, intestinal pain, diarrhea and vomiting. Notify your physician of PP exposure. A special canister is required for gas masks as protection from PP up to 0.5 percent in air.

Uses:

READ THE LABEL. Very highly toxic to insects although requiring 72 or more hours of treatment time (aluminum phosphide tablets evolve PP rather slowly, needing 24 to 48 hours to react with atmosphere moisture—may take longer at low humidities). Preadult stages of some insects are resistant to short exposures to PP but are controlled by a 10-day (or more) fumigation period.

Sulfuryl fluoride (Vikane) at a glance-

Required Clothing:

- Full-body clothing and shoes, no gloves, no rubber boots.
 - Wear goggles or full-face shields when handling the liquid, such as opening the cylinder to introduce gas into the structure.
- 0–5 ppm none required.

>5 ppm NIOSH/MSHA self-contained breathing apparatus, or combination air-supplied/SCBA respirator.

Uses:

What—Furnishings, dwellings, buildings, vehicles.

Where—Structures, tarpaulins, chambers. Avoid food, drugs, and plants.

Fumigation

Sulphuryl Fluoride (SF) (Vikane)

Properties:

Colorless, odorless gas. Noncorrosive and unreactive to most materials. Good penetration of dry wood products and fabrics but requires fans to get good distribution. Not an efficient ovicide.

Fire hazard:

Nonflammable. In presence of open flame or electric heating element, SF forms a very corrosive gas.

Human hazard:

Highly toxic gas requiring proper precautions on part of applicator. Maximum exposure limit is 5 ppm for 40-hour week. Special canisters are required for concentrations above that amount. Exposure symptoms include respiratory irritation and depression. Notify doctor in cases of exposure (manufacturer supplies first-aid booklet).

Uses:

READ THE LABEL. Not registered for any food or drug item. Registered for dry-wood termites, powderpost beetles, wood boring beetles, bedbugs and clothes moths. Very effective against larva and adults but not effective against egg stage at regular fumigation concentrations. Aeration removes fumigant rapidly from treated commodities. (SF may be trapped in plastic clothes bags or waterproof mattress covers). Not commonly used in Kansas.

Types of Fumigation

Tarpaulin Fumigation

Tarpaulin fumigation involves the placement of a gas-tight material over the commodity or structure to be fumigated. The tarps may be specially made for fumigation, such as impregnated nylon, or they may be sheet polyethylene.

Polyethylene tarps can be used in thicknesses from 1½ mil. up to 6 mil. Because clear polyethylene breaks down from exposure to sunlight, use black polyethylene films outdoors. Gas impervious adhesive tape may be used to join various sections to polyethylene film. Consideration must be given to the

method of obtaining a ground seal. If they are smooth, concrete and asphaltic surfaces are satisfactory. Wood surfaces are not. With wood, and soil surfaces, it is necessary to place a section of the tarp material beneath the stack as well as over it.

There are several methods of obtaining a good ground seal. Allow enough tarp materials to skirt outward at least 18 inches from the stack. Loose sand, sand snakes, or water snakes are used to hold the skirt to the ground surface. Snakes are merely tubes of cloth or plastic filled about three-fourths full with sand or water. The snakes should overlap each other about 1½ feet.

Occasionally, a stack may be too close to a wall to obtain a good ground seal. The solution is to seal the tarp directly to the wall with adhesive tape. Tarpaulin fumigation may be performed either indoors or outdoors. Outdoor fumigation should allow for winds or weather which may disrupt a fumigation attempt.

Advantages: Fumigation is limited to items under the tarpaulin, economical use of fumigant, work may continue in general area (providing tarpaulin is reasonably impervious to fumigant vapors).

Disadvantages: Extra labor of placing and sealing tarpaulins, fumigant may be lost through floor or absorbed by soil moisture.

Atmospheric Vault Fumigation

These are usually small buildings located well apart from other structures. Some are specially built for fumigation, others are modified from other structures. Gas concentrations can be monitored through a permanent arrangement. Cased, bagged or palleted commodities are easily moved in and out of the vault without special preparation. The fumigator does not have to compute the cube of the structure each time the fumigation will take place. Almost any fumigant can be used. And while safety precautions must be observed, fewer considerations are necessary.

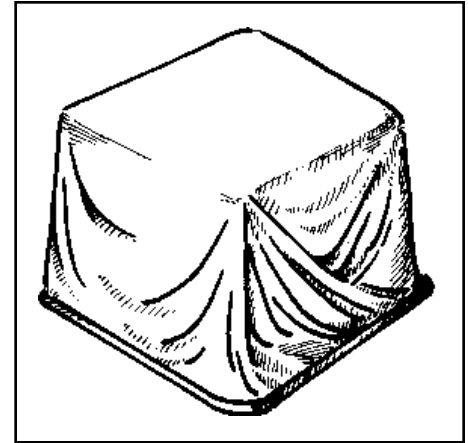

Tarpaulin fumigation

Fumigation

Advantages: Good control of fumigation, safer than fumigating in buildings, excellent for palletized cargoes.

Disadvantages: Initial cost of setting up a fumigation vault, cost of moving the commodity to and from the chamber, the limited quantity of items that most vaults will hold and economical utilization of facility.

Portable Chambers

A portable fumigation system, developed by B & G Equipment Company, Plumsteadville, Pennsylvania, brings added flexibility to an applicator who may need to fumigate small quantities of items or commodities in various locations. The components of the system are: two pieces of heavy-duty vinyl sheeting that can be zipped together, similar to food storage bags, fumigation dispensers, connecting hoses, security lock, gas concentration monitoring valve, carrying case, and a gas discharge stand pipe.

The system is designed to allow the operator to develop a vacuum inside the bubble. The vacuum will pull the flexible bubble around the

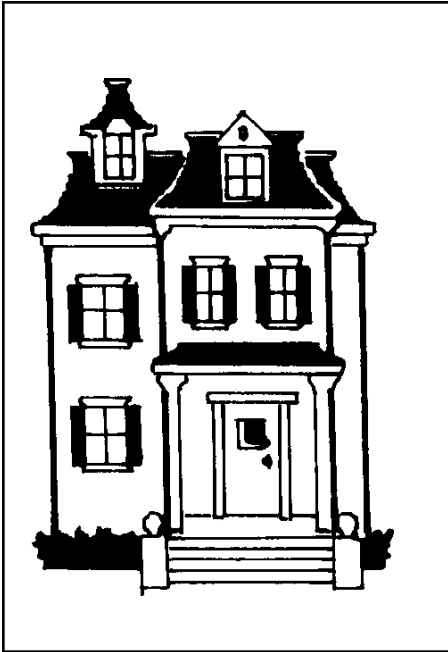

Structural fumigation

Gas concentration test leads must be run throughout the structure and the gas concentrations monitored.

Electric fans should be placed so the fumigant will be circulated throughout the structure in order to achieve rapid equilibrium of the fumigant. Local fire authorities may require the use of non-sparking fans. It may be difficult to compute the cube of the structure. It is very easy to overlook vents, cracks, conduits, etc., that may permit the gas to escape.

Items which could be damaged by the fumigant must be removed. Building occupants must be evacuated for the entire fumigation and aeration period. All pilot lights, flames, and electrical heating elements must be turned off. If ornamental vegetation is too close to the structure to permit the tarpaulin to be sealed to the ground, the vegetation will have to be moved. All edges of the structure which could puncture, or tear the tarpaulin must be well padded.

Precautions and Protective Equipment

Fumigants as a class are the most toxic of all pesticides. Because they are highly volatile, penetrating and highly toxic, they are considered a threat to human life if not used with proper precautions. Therefore, it is essential that fumigants always be used with proper precautions, procedures and protective equipment.

You may be cited by EPA, the state lead agency and/or OSHA for failing to follow instructions in the use or care of protective equipment, as well as the misuse of a pesticide. Directives issued by these agencies and instructions on pesticide labels must be observed. The information given here is to help you better appreciate the need for following procedures for protection and some general instructions. No safety suggestions cover all situations. Follow the label instructions. Remember, there is no substitute for good common sense.



KEEP OUT OF REACH OF CHILDREN
DANGER—POISON—PELIGRO



Danger

commodity. After collapsing the bubble, the fumigant is applied. Normal safety precautions are necessary, including a self-contained breathing apparatus (SCBA), and monitoring tools to test for leaks.

Structural Fumigation (by taping and sealing)

This essentially is a modification of vault fumigation. No tarp is used and the entire structure becomes a fumigation vault. The building must be of the proper construction (brick, concrete, stucco, etc.) for a tape and seal fumigation. The roof may need to be tarped if its construction alone will not provide a leak-free barrier.

Fumigation

Threshold Limits

Threshold limit values (TLV) refer to airborne concentrations of substances and represent conditions under which nearly all workers may be repeatedly exposed day after day without adverse effect. Because of a wide variation in individual susceptibility, however, a small percentage of workers may experience discomfort from some substances at concentrations at or below the threshold limit; a small percentage may be affected more seriously by aggravation of a preexisting condition or by development of an occupational illness.

Threshold Limit Values:

The Threshold Limit Value-Time Weighted Average (TLV-TWA) is the time weighted average concentration for a normal 8-hour workday and a 40-hour workweek, to which nearly all workers may be repeatedly exposed, day after day, without adverse effect.

Warning Gases

Materials such as chloropicrin may be added in low concentrations to an odorless fumigant so an individual can be made aware of the presence of a harmful gas. However, they must not be relied upon as the only safeguard for protection, anymore than you would rely upon the detection of a fumigant by its own odor. It must be stressed that:

- Individuals vary in their ability to detect odors and levels of odors.
- The warning gas may have different physical properties than the fumigant and the mixture may stratify, separate or be absorbed at a different rate providing a false sense of security.
- Odors do not tell you the concentration of fumigant present.
- You may suffer odor fatigue which is the loss of the ability to smell the particular warning agent.

Warning gasses serve a useful purpose, but are not foolproof. Use them as one of the tools, not as the only tool!

Transporting a Fumigant

Due to the highly toxic nature of fumigants and the lack of control over fumes released as the result of leaks, spills, or other accidents, the following precautions should be taken:

- Do not transport fumigants by public transportation such as subways, buses, trains or taxis.
- Do not transport fumigants through tunnels without the knowledge and permission of the proper authorities.
- Do not transport fumigants in closed vehicles in the same common airspace as personnel.
- Mark the vehicle in which the fumigant is being transported by attaching the appropriate placards as required by the Department of Transportation (DOT) to the front, back and sides of vehicles.
- Transport cylinders upright and secured.
- Mount cylinders so they are protected from rear-end collision.
- Do not remove valve protection bonnet until immediately before fumigant application.

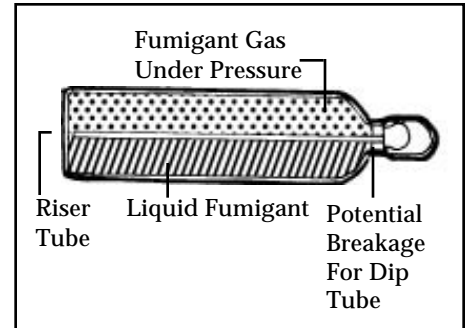

Problems with Horizontal Transport

Threshold Limits

	Parts Per Million (ppm)	
	Approx. Odor Threshold	TLV-TWA
Methyl bromide	Odorless	5
Phosphine	0.14	0.3
Sulfuryl fluoride	Odorless	5

Fumigant Toxicity and Flammability

Fumigant	Toxicity to Humans	Flammability (Explosive Concentrations in Air)
Phosphine (PP)	Very high	Very (1.79%)*
Methyl Bromide (MB)	Medium	Non-flammable
Sulfuryl fluoride (SF)	Very high	Non-flammable

*Phosphine reacts with copper alloys, silver and gold, giving severe corrosion. Such metals should be protected from the gas.

Fumigation

Respiratory Protection Devices

The General Manual has additional and similar information concerning respiratory protection beginning on page 96. You are strongly encouraged to be aware of that information as well as the following information.

Gas Masks

The respiratory protection devices that furnish the minimum protection are the full-face gas masks equipped with canisters. For protection the canister must be suitable against the fumigant being used.

The canisters contain chemicals that adsorb the fumigant, and may also contain a filter. The life of the canister is limited and varies with the fumigant used and the fumigant concentration. The maximum permissible limits are usually stated on each canister. Do not exceed these maximum limits. The canister color code for the various fumigants are shown below.

There are several reasons for using devices other than full-face gas masks with chemical canisters for respiratory protection. The canisters have limited life. Special canisters must be available for each fumigant. The canisters provide no protection at abnormally high fumigant concentrations. They provide no protection in spaces where oxygen is deficient.

General Rules on Canister Use

1. Discard any canister that has been used for more than 30 minutes (total time) in a fumigant atmosphere.
2. Discard any canister whenever an odor of fumigant is detected coming through (the adsorption material is not working).

3. Discard any canister used for less than 30 minutes if it is more than 1-year old.
4. Discard canisters with expired expiration dates or more than two years after manufacture (even if unused) unless instruction sheet specifically says otherwise.
5. DO NOT use a canister-type gas mask to enter a freshly fumigated area. The concentration of fumigant will overpower the adsorbent material.

Self-Contained Breathing Apparatus

There are two types of these devices. One is the air pack and the other is the oxygen breathing apparatus (OBA).

Air Pack

With this device, the full-face mask is attached to a tank of air carried on the back of the fumigator. This device gives the fumigator the mobility of the canister mask and does not tie the fumigator to an air pump. Except for concern about skin absorption of the fumigant, the fumigator can work in any gas.

With the popularity of SCUBA diving, it is not difficult to get the air tanks refilled. Depending upon the size of the tank, the air supply will last up to an hour. There usually is a warning bell that can be set to warn the fumigator when the air supply is running low. The disadvantage of the air pack is that the fumigator has to carry a heavy tank while completing the work.

Oxygen Breathing Apparatus (OBA)

The oxygen breathing apparatus is similar to the air pack. Instead of a tank to carry, a special canister generates the oxygen supply. The canister is lightweight, and is usually worn on the chest. To operate, the fumigator places the canister into its place, and blows into the air supply tube once or twice. The moisture from the breath activates the chemicals in the canister, which then provides a supply of oxygen. The supply is good for about one hour.

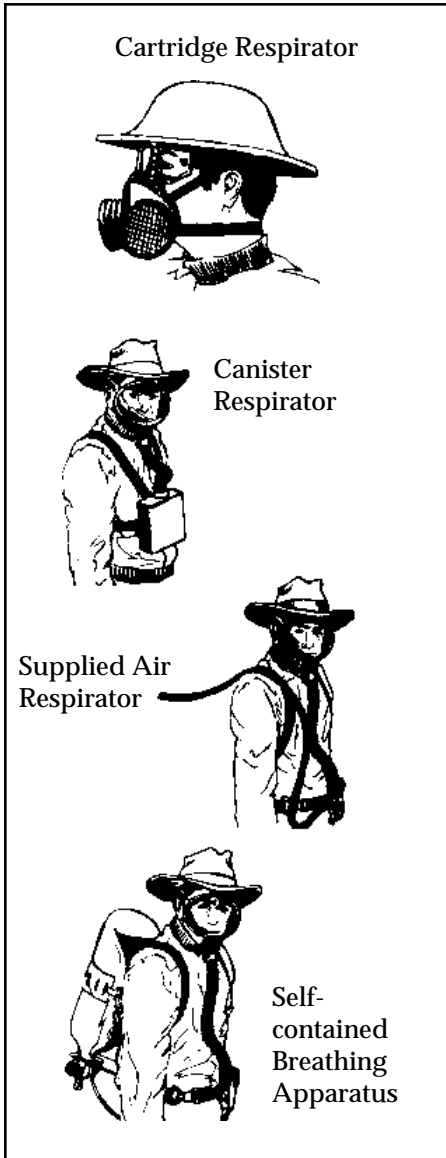

Respiratory Protective Devices

Fumigant Color Code

Methyl Bromide	Black
Phosphine	Yellow with gray stripe
Sulfuryl Fluoride	White with gray stripe

There usually is a warning bell that can be set to warn the fumigator that the life of the canister is about expired. Care must be taken and directions closely followed for the disposal of the oxygen generating canisters.

Symptoms

All workers in areas where fumigants are being used should be aware of the symptoms of light exposure to the fumigants. Such symptoms are warnings that the concentration of fumigants in the air is too high for continued safety of personnel.

Symptoms of Light Exposure to Fumigants

1. Headache
2. Dizziness and equilibrium disturbances
3. Visual disturbances
4. Irritation of respiratory tract (leads to more "lung colds," asthma attacks, and other lung and throat problems)
5. Narcosis (desire for sleep, drowsiness)
6. Muscle cramps—especially in arms and legs

NOTE: The ingestion of alcoholic beverages will intensify the symptoms and effects of fumigant poisoning.

Preparing for Fumigation

All new employees should have a thorough physical examination before performing any fumigation duties whatsoever. The examination should include a liver function test and a respiratory capability test (or equivalents).

All persons working with fumigants should have a complete physical examination every six months. Again, the examination should include liver function capability and respiratory capacity.

Understand fully the facility and commodity being fumigated, including the:

- design of the structure, as well as adjacent and connecting structures both above and below ground.

- persons or animals expected to be at or near the area being fumigated.
- the item, its history and condition (previous fumigation, temperature, moisture).
- availability of emergency shutoff stations for electricity, water and gas.
- location of nearest telephone, and phone numbers for fire and police departments, hospitals and physician.

Understand label directions, warnings, and antidotes. You may need to notify local medical, fire, police authorities and other security personnel about:

- chemicals being used.
- proposed date and time of use.
- type of respiratory protection required.
- fire hazard rating.
- name and phone number of person to contact in event of emergency.

Have alternate application and protective equipment and replacement parts available. Display warning signs near points of entry and provide for security of buildings. Have necessary first-aid equipment available. Before treatment is started, develop plans to ventilate the area when the treatment period is over.

Security guards may be necessary if the structure is at an exposed location where the public (especially children) may attempt unauthorized entry. Security guards also may be needed if plant operations do not permit the security of the fumigated area. The guards must have the authority to refuse entry to anyone not wearing protective equipment. They should have suitable protective equipment available if an emergency requires entry into the fumigated area. They should also be trained in first-aid procedures for fumigant poisoning and have the appropriate materials readily available.

Precautions include an accounting of all personnel known to be working in the area, a room by room and floor by floor check to ascertain that no

Fumigation

person has been overlooked and the use of a portable public address system (bull horn) in each space to warn anyone present of the imminent fumigations. If bells, whistles or other devices are used to give warning signals, all personnel must have been instructed as to the meaning of these signals.

Doors, windows and other points of access must be locked or otherwise secured against accidental or unauthorized entry into fumigated areas. Preferably there should be one person ultimately responsible for evacuating all people, securing the affected area, and restricting access until the area has been cleared of the fumigant.

Notices of fumigated areas must be provided to night watchmen, janitors, maintenance crews and others who otherwise might have master keys and ready access into the fumigated area. None of these should enter a fumigated area except in an emergency and then only with adequate protection.

Other prefumigation precautions. (1) All possible sources of fire must be eliminated. Turn off all pilot lights, gas burners, oil burners and electrical equipment; (2) if possible, provide for the start of post-fumigation ventilation by controls outside of the fumigated area; (3) if several floors or rooms are involved, rehearse the fumigation sequence so everyone knows where the others are and where to exit the area; (4) discuss emergency plans for handling all possible problems; (5) locate a nearby telephone for use in case of an emergency; (6) have fumigant testing equipment available and check it for proper operation; (7) have first-aid materials ready and available; and (8) must notify fire departments.

Premises Inspection

Once it appears that fumigation will be required to control a pest problem, you must conduct a serious on-site inspection. You must ask yourself a number of questions and

make a number of decisions. Frequently, the success or failure of the fumigation operation will depend upon what you learn, what you decide and how you plan. Some of these questions should include:

- If the structure itself is not infested, could the infested items be moved from the building and fumigated elsewhere?
- Assuming that removal of the infested items from the building is not practical, can you fumigate the items in place?
- Is there enough room between the items and walls or partitions so you can seal the tarp to the floor?
- What is the cube of the items?
- What is the cube of the building?
- Can the structure itself be made reasonably airtight, or will it be necessary to tarp the entire building?
- From what construction materials is the structure built?
- Are there broken windows that must be replaced?
- Are there cracks in the ceiling, walls or floors that must be sealed?
- Are there floor drains or cable conduits that will require sealing?
- Are there hidden floor drains under stacked items?
- How are you going to handle air conditioning ducts and ventilation fans?
- Will interior partitions interfere with fumigant circulation?
- Are the interior partitions gas-tight so they can be relied upon to keep the fumigant from entering other parts of the structure?
- Are there parts of the building not under the control of your customer?
- Can these other operations be shut down during the fumigation?
- What are building contents?
- Can any of them be damaged by the fumigant?

- Can such items be removed during the fumigation?
- If they cannot be removed, can they be otherwise protected?
- Where are the electrical outlets?
- Of what voltage are they?
- Will the circuits be live during fumigation?
- Can the outlets be used to operate your fumigant circulating fans?
- Look outside the building. If you tarp the entire structure, can you make a good, tight ground seal?
- Is there shrubbery next to the building that might be damaged either by the fumigant, or by your digging to make an air-tight fumigation seal?
- Can this shrubbery be moved?
- How far is it to the nearest building?
- Does that building have air conditioning?
- Does it have air intakes that could draw the fumigant inside—particularly during aeration?
- How are you going to aerate your structure after fumigation?
- Are there exhaust fans and where are the fan switches?
- Are there windows and doors that can be opened for cross ventilation?
- Does the building contain any high-priority items that may have to be shipped within a few hours notice?
- If so, can you make provisions for interrupting the fumigation and aerating the building within a certain time requirement?
- Is the structure to be fumigated so located that your operations may attract bystanders? (If so, you should consider asking for police assistance to augment your own guards.)
- Once you are convinced that you have covered everything, prepare a check list of things to do and of materials needed. Don't rely upon your memory.

Then finally three questions:

- (1) What have I overlooked?
- (2) Is fumigation still the best method of controlling the pest problem?
- (3) Am I qualified to do the fumigation?

Placarding of Fumigated Areas

The applicator must placard or post all entrances to the structures and/or rooms containing equipment under fumigation with signs in English and Spanish, bearing:

- The signal word DANGER/ PELIGRO and the SKULL AND CROSSBONES symbol in red.
- The statement "Area and/or items under fumigation, DO NOT ENTER/NO ENTRE."
- The statement, "This sign may only be removed after the items are completely aerated (contains 0.3 ppm or less of hydrogen phosphide gas). If incompletely aerated item is transferred to a new site, the new site must also be placarded if it contains more than 0.3 ppm. Workers must not be exposed to more than 0.3 ppm hydrogen phosphide."
- The date and time fumigation begins and ends.
- Name of fumigant used.
- Name, address and telephone number of the applicator.



All entrances to a fumigated area must be placarded. Where possible, placards should be placed in advance of the fumigation to keep unauthorized persons away. Do not remove placards until the treated equipment and surrounding work areas are aerated down to 0.3 ppm hydrogen phosphide or less.

Application

Always assign two persons to each fumigation. Everyone involved in the fumigation should know first-aid and other emergency procedures, including personal decontamination.

Follow label directions exactly when applying a fumigant. Consider prevailing winds and other pertinent

DANGER

PELIGRO

AREA AND/OR COMMODITY UNDER FUMIGATION, DO NOT ENTER/NO ENTRE

This sign may only be removed after commodity is completely aerated (contains 0.3 ppm or less phosphine gas). If incompletely aerated commodity is transferred to a new site, the new site must also be placarded and workers must not be exposed to more than 0.3 ppm phosphine.

FUMIGATION WITH

Brand Name: _____

Fumigation Being Performed By	Date of Fumigation	Emergency Telephones
NAME: _____	Date Applied: _____, 19____ Day: _____	_____
ADDRESS: _____	Do not open: _____, 19____ AM _____ PM _____	_____
	Before: _____ AM _____ PM _____	

Fumigation

weather factors such as temperature and humidity. Apply fumigants from outside the exposed areas whenever possible.

Return to the storage area all unused chemicals in clearly labeled, original containers. Dispose of empty containers correctly.

Provide watchmen when required. Secure entrances with guards or locks. Post warning signs.

Report to company-retained physician or to designated personnel, indications of illness or physical discomfort, no matter how minor they seem. These symptoms and signs may include dizziness, nausea, headaches, and lack of coordination.

Do not consume alcohol for 24 hours before or after a fumigation. Do not eat or smoke during application.

After Application

Aeration procedures vary according to the fumigant being used, the method of fumigation and the items being fumigated. Because of these factors always read and follow the label instructions for the fumigant and situation in which it is being used.

Before re-entry, use a suitable gas detector, as indicated on the label, to determine fumigant concentration. Do not depend on odors. Some fumigant gases are odorless. Wear correct respiratory equipment.

Turn on all ventilating or aerating fans. Check for gas concentrations in areas that are expected to aerate slowly. Remove warning signs only when the gas concentration is within safe limits for human exposure.

Factors Affecting Aeration Time

In addition to the characteristics of the fumigant itself, the rate of ventilation or aeration is affected by several factors. The more important of these are:

- Rate of air exchange.
- Temperature.
- Sorption and desorption.

The rate of air exchange and the temperature controls the amount of sorption and the rate of desorption.

Free gas should be released and items aerated immediately following fumigation. It is important to consider and protect human health at all times. When a fumigation chamber is inside any other enclosure where employees are likely to be present, intake and exhaust stacks should be provided. The exhaust stack must lead outside the building. The intake and exhaust stacks should be opened after the fumigation exposure is completed. The normal air circulation equipment in a chamber can be made to conduct air from the chamber to the outside.

When a chamber is outside a building, it may be aerated safely by opening the door slightly at the beginning of the aeration period and turning the blower on. The door should be held in the partially opened position so it cannot accidentally close. Air discharged from the blower should be vented to the outside.

Remove and dispose of packaging and waste products of solid fumigants.

Safe Use of Fumigants

There is a tendency for employees who commonly work with fumigants to become lax in their safety precautions. ALL FUMIGANTS CAN BE LETHAL if they are used carelessly or without adequate safety precautions.

Humans can be poisoned by inhaling the gases of fumigants and by absorption through the skin. Most commercial products have an unpleasant odor but the pure chemicals can be either odorless or have a sweet smell.

Do not wear jewelry, bandages, gloves, contact lenses or tight-fitting clothing when applying fumigants. These articles may trap gases causing blistering or burning of the skin.

Safety Recommendations (Summary)

1. Carefully read the labeling and follow instructions explicitly.
2. Post warning placards on fumigated areas.
3. Prior to fumigation, notify appropriate company employees. Provide relevant safety information to local officials on an annual basis for use in the event of an emergency.
4. Never fumigate alone from inside structures.
5. Never allow uninstructed personnel to handle the fumigant.
6. Approved respiratory protection must be available for fumigation inside structures.
7. Wear dry gloves of cotton or other materials if contact with metal phosphide tablets, pellets or dust is likely. Aerate used gloves and other contaminated clothing in a well ventilated area prior to laundering. Wash hands thoroughly after handling metal phosphide materials.
8. Never open metal phosphide fumigant pouches in a flammable atmosphere. It is preferable to open them in open air, near a fan or other appropriate ventilation which will rapidly exhaust contaminated air.
9. Do not allow the metal phosphide to pile up or contact liquid water.
10. Dispose of empty containers and spent metal phosphide fumigant in a proper manner consistent with the label instructions.
11. Hydrogen phosphide fumigants are not to be used for vacuum fumigations.
12. Exposures to hydrogen phosphide must not exceed the eight-hour TWA of 0.3 ppm during application, or a ceiling concentration of 0.3 ppm after application is completed.
13. Fumigated areas must be aerated to 0.3 ppm hydrogen phosphide or less prior to reentry by unprotected workers.
14. Transfer of a treated commodity to another site without complete aeration is permissible provided that the new storage site is placarded if its concentration is above 0.3 ppm and workers are not overexposed during transfer.
15. Do not open pouches until just prior to application of the Prepacs.
17. Protect or remove materials containing metals such as copper, silver, gold and their alloys and salts from corrosive exposure to hydrogen phosphide.
18. Do not use metal phosphide fumigant containers for any purpose other than recycling or reconditioning.
19. Two trained persons must be present during reentry into fumigated and/or partially aerated structures or rooms housing treated equipment.

Fumigation

Questions

1. (40) Pesticides which by themselves or in combination with other substances become gas are called
 - a. aerosols
 - b. fumigants
 - c. wettable powders
 - d. dusts
2. (41) Even when this building material is well sealed, it does not retain a fumigant very well.
 - a. plastic
 - b. metal
 - c. wood
 - d. concrete
3. (42) This fumigant is highly flammable in air.
 - a. methyl bromide
 - b. phostoxin
 - c. vikane
 - d. carbon dioxide
4. (43) For tarp fumigation, polyethylene tarps with a minimum thickness of _____ can be used.
 - a. ½ mil.
 - b. 1 mil.
 - c. 1½ mil.
 - d. 2 mil.
5. (44) As a class, _____ are the most toxic of all pesticides.
 - a. organophosphates
 - b. organochlorines
 - c. phenoxy herbicides
 - d. fumigants
6. (45) Threshold limit values (TLV) refer to _____ concentrations.
 - a. water borne
 - b. soil borne
 - c. airborne
 - d. pesticidal limits
7. (46) The respiratory protection device that provides the minimum protection is the
 - a. full face gas mask with canisters
 - b. Air Pack
 - c. Oxygen breathing apparatus
 - d. full face mask with supplied air
8. (47) Symptoms of light exposure to fumigants include:
 - a. headache
 - b. irritation of respiratory tract
 - c. muscle cramps
 - d. all the above
9. (48) Once it appears fumigation is necessary, you must:
 - a. call in two consultants
 - b. conduct a serious on-site inspection
 - c. contact the Department of Health
 - d. contact the police and fire departments
10. (49) Warning signs for fumigation must be printed in:
 - a. German and French
 - b. German and Spanish
 - c. English and German
 - d. English and Spanish
11. (50) Factors affecting aeration time include
 - a. rate of air exchange
 - b. temperature
 - c. sorption and desorption
 - d. all the above

Notes

Notes

Answers to Study Questions

Pages 5–8

1. a 2. c 3. a 4. b 5. a
6. d 7. d 8. a

Pages 10–14

1. a 2. c 3. b 4. d 5. a
6. b 7. c

Pages 16–18

1. c 2. d 3. d 4. a 5. c
6. d

Pages 22–27

1. b 2. a 3. d 4. c 5. a
6. c 7. a 8. b 9. a

Pages 29–31

1. d 2. a 3. d 4. d 5. a
6. b

Pages 33–35

1. b 2. d 3. c 4. c 5. c
6. b

Pages 37–38

1. d 2. d 3. a 4. b 5. c

Pages 40–51

1. b 2. c 3. b 4. c 5. d
6. c 7. a 8. d 9. b 10. d
11. d

Donald C. Cress
Extension Pesticide Coordinator

AUTHORS: Appreciation is expressed to the following for preparation of the material in this manual:

Donald C. Cress, Extension Pesticide Coordinator, Kansas State University, Manhattan, Kansas

Steve McKinzie, Kansas Pest Control Assoc., Manhattan, Kansas

Jack Watkins, Senior Sales Specialist, DowElanco, Shawnee Mission, Kansas

ACKNOWLEDGEMENT: Appreciation is expressed to the following for cooperation in the Pesticide Applicator Training Program:

Jeanne Fox, Ecological Specialist, Pesticide Use Section, Plant Health Division, Kansas Department of Agriculture

Dan Tuggle, Case Review Officer, Pesticide Use Section, Plant Health Division, Kansas Department of Agriculture

This manual contains information adapted from Daryl Sanders, University of Missouri, and Ronald Garder, Cornell University.



Kansas State University

KANSAS
STATE
UNIVERSITY

Agricultural Experiment Station and
Cooperative Extension Service

S-8 (Revised)

March 1997

Issued in furtherance of Cooperative Extension Work, acts of May 8 and June 30, 1914, as amended. Kansas State University, County Extension Councils, Extension Districts, and United States Department of Agriculture Cooperating, Richard D. Wootton, Associate Director. All educational programs and materials available without discrimination on the basis of race, color, national origin, sex, age, or disability.

File Code: Pesticides—2

3-97—3M