

Terraces must have adequate capacity, ridge height and channel width, to accomplish their purpose for soil and water conservation. Without adequate capacity to carry water, terraces will be overtopped by runoff in a heavy storm. Overtopping can cause erosion of the terrace ridge, terrace back slope, and lower terraces and can result in severe gully formation.

Terraces are typically designed to have a runoff carrying capacity from a 1 in 10-year storm: storms that have a 10 percent chance of occurring in any one year. This provides very little safety margin. Protection from big storms can be enhanced by conserva-

tion tillage practices that maintain residue on the soil surface and by contour farming, which reduces or delays runoff.

Terraces need regular maintenance to remain functional. This publication provides guidelines on how to properly maintain terraces to serve their intended purpose.

Erosion by water, wind, and tillage wears the ridge down and deposits sediment in the channel, decreasing the effective ridge height and channel capacity. The amount of capacity loss depends on the type and number of tillage operations, topography, soil properties, crop residue, and precipitation. Terrace maintenance restores capacity by removing sediment from the channel and rebuilding ridge height.

Annual terrace maintenance is necessary in some situations, although less frequent maintenance is adequate in others. Typically, more frequent maintenance is required for steep slopes and/or highly erodible soils. Intense tillage operations and intense rainfall runoff also increase maintenance needs.

Level channels with no outlet are used in low precipitation regions when soils have adequate infiltration rates. Gradient terraces where channels slope toward an outlet are the most widely used in Kansas.

Parallel terraces are constructed on spacings that match machinery widths and are placed perpendicular to the dominant slope. Parallel terraces improve farmability and eliminate or minimize point rows. In addition, terraces also can have several different cross-sectional shapes.



Photo 1. Measuring the ridge height above the channel is easily done with a straight board, carpenters level, and tape measure.

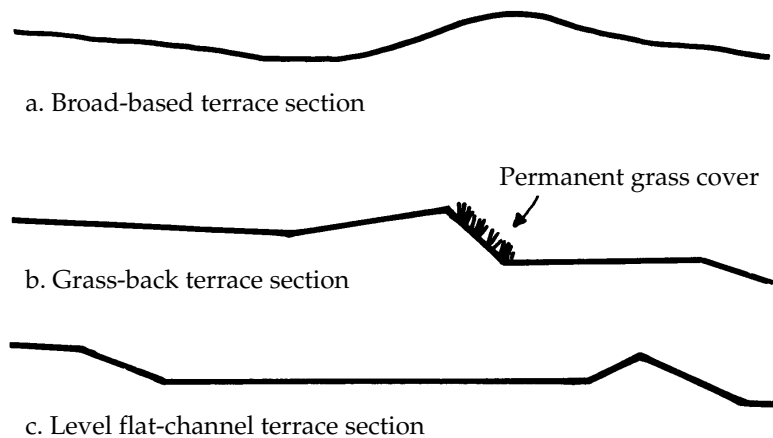

Figure 1. Three terrace cross-section shapes.

Terrace Shapes

Three terrace cross-section shapes are commonly used in Kansas as shown in Figure 1: (a) broad-base, (b) grass-back, and (c) level, flat channel. Broad-based terraces may be constructed as a three-segment or as a wide, smooth cross-section. Procedures to maintain the various terrace sections differ. Changing from one type of terrace to another will require considerable work and possibly the use of earthmoving equipment.

Broad-base section. The broad-base terrace section is by far the most common shape used in Kansas. This terrace section is used for gradient or level terraces on the contour and parallel. The broad-based section may be either a three-segment section as shown in Figure 2 or a wide, smooth section as shown in Figure 3.

The three-segment section is easy to visualize, construct and maintain. Three uniform segment lengths are selected to best fit present and anticipated future tillage, planting, and harvesting equipment sizes. These segments form the channel and ridge.

Many producers using large equipment prefer slope lengths of 24 feet or more, which is considerably larger than the minimum recommended by the Natural Resources Conservation Service (NRCS). Minimum channel width would be two times the slope length, as shown in Figure 2, and the height for a new terrace should be at least 16 inches. However, slopes over 5 percent in eastern Kansas may require an 18-inch height. Maintenance must be done so minimum height for this section is 12 inches.

The minimum size recommended for the wide, smooth section is 25 feet from the channel to the ridge, with an overall width of about 75 feet (Figure 3). The smooth section shape is recommended when field operations must cross the terrace, i.e., when following the average contour for a field or parallel to field boundaries over terraces. The larger, smooth shape for the channel and ridge allows field operations to cross the terrace, while ensuring safety for the operator and minimal chances for damage to the terrace or the equipment. Because tillage over the terrace tends to reduce the height, the minimum height for the ridge is 16 inches. That is, perform maintenance so that the ridge height is never less than 16 inches.

Grass-back section. The grass-back terrace section shown in Figure 1-b often is used on slopes greater than a few percent where broad-based terrace sections

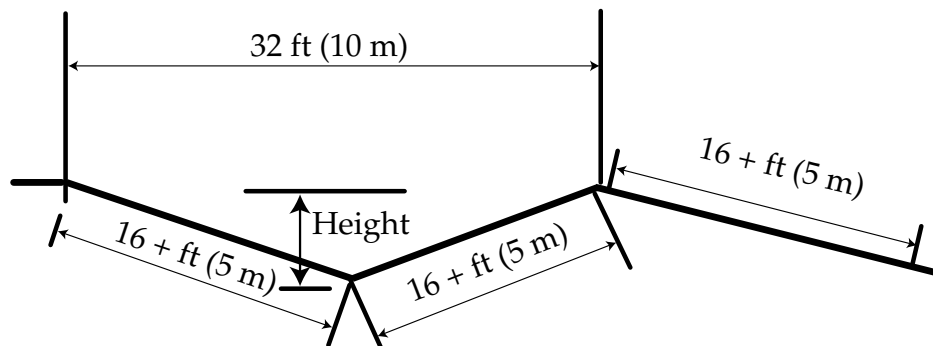

Figure 2. Three-segment terrace section recommended when farming parallel to terrace. (Length of segments should fit equipment used.)

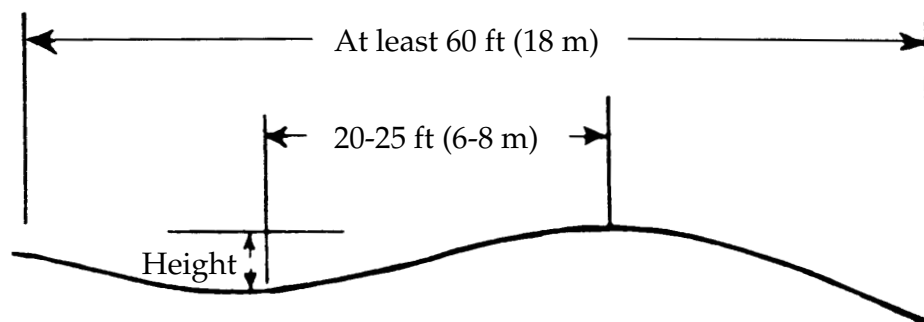

Figure 3. Wide, smooth terrace section recommended for crossing the terrace with equipment.

are less practical. Because of the steep backslope, there is often a considerable elevation difference between the ridge and the toe of the back slope. The grass-back section reduces the slope of the tilled field by about 2 percent. By contrast, broad-based terraces increase the slope from the ridge to the channel below in many situations by 2 percent or more. The minimum height for the grass-back section prior to maintenance is at least 18 inches.

Level, flat-channel section. This section has been used in low rainfall areas where wheat-fallow and wheat-sorghum-fallow crop rotations are common. The level, flat channel shown in Figure 1-c collects runoff from the sloped area above and allows the water to infiltrate over the flat channel. When runoff from the slope is adequate, and the channel is wide enough, the channel may be cropped annually while the slope is periodically fallowed.

Check for needed repairs

Terraces degrade naturally by erosion and sediment, and can be damaged by machinery, animals, and

settling. Check terraces and terrace outlets regularly (at least annually) for needed repairs. The best time to check is after rains, when erosion, sedimentation, and unevenness in elevation are easiest to see (Photo 2). Specific items to note are low or narrow terrace ridges, water ponding in the channel, terrace outlets, erosion, and sediment clogging near waterway or pipe outlets.

Measuring terrace height and width. Terraces need adequate size and capacity to properly function. Use measurements, not guesses, to evaluate the adequacy of terrace size. Terrace height, the difference between the channel bottom and ridge top, is easily measured with a straight board, carpenters level (or string and string level), and tape measure. Width is similarly measured with a string, string level, and tape measure (Photo 1). Gradient terraces should have a minimum height, before maintenance, of at least 1 foot. See Figures 2 and 3. When the height is less than 1 foot, first correct the shape and build up the ridge enough to ensure the 1-foot minimum before the next maintenance. Significant settling occurs with loose soil in the terrace ridge, so overbuild the terrace to allow for settling and erosion. Level terraces should have a 1.6 foot minimum height. Overtopping or ridge breaks indicate inadequate height and channel capacity, regardless of size.

Calculate the cross-sectional area of a terrace channel using the following equation. Where H = height of ridge above the channel and W = width of channel measured to an uphill point at the same elevation.

$$\text{Area}_{\text{X-Section}} = \frac{H_{\text{Ridge}}}{2} \times W_{\text{Channel}}$$

For a broad-based terrace, the minimum channel width should measure at least 32 feet before general maintenance. See Figure 2. The cross-sectional area for a V-shaped channel should be at least 16 ft² (1 foot deep by 32 feet wide).

Terrace ridge. Low or narrow places in the terrace ridge may result from settling, tillage, machinery crossing the ridge, or erosion from overtopping. Inadequate ridge height is a common problem where overtopping has occurred or where repeated tillage operations cross the terrace (such as adjacent to a waterway). A blade, scraper, front end loader, or other earthmoving equipment is an ideal way to reinforce and build up the ridge in these small areas. It works best to make these repairs before general maintenance is done.

Ponding in channel. Ponding in terrace channels is costly because of lost crop production and reduced

tillage efficiency. During wet periods, it may be necessary to bypass the wet spots. Correcting this problem requires lowering the channel downstream from the low area or filling the spot so water freely drains from the ponding area. Observe the depth of ponded water and measure to determine the depth of cut or fill required. Sediment deposits eroded from rills or gullies, or settling are frequently the cause of poor channel drainage. Use soil removed from the channel to reinforce the terrace ridges or spread it in field low spots.

Terrace outlet transition. For gradient terraces, the outlet end of the terrace must drain freely to prevent terrace overtopping near the outlet and ponding in the channel. The transition to the outlet should have a cross-sectional area at least equal to or greater than the terrace channel. Correct inadequate transition capacity by cleaning the transition and adjacent channel and building up the ridge near the outlet. Tillage over terraces adjacent to the outlet contributes to inadequate capacity and low ridge height. Eliminating tillage that runs parallel to the waterway or taking the tool out of the ground when crossing the terrace helps prevent this problem. Mow grass in the outlet regularly and remove sediment deposits in the transition to the outlet.

Pipe outlet. For underground pipe outlet systems, the ponding area around the inlet riser should be large enough to contain rainfall runoff without overtopping. Additionally, the ponding area must also contain storage for sediment accumulation during the maintenance interval. Remove sediment from the ponding area periodically, especially after large rainfall events. Remove debris and tall vegetation from the area around the inlet riser. Clear the holes of obstructions for the inlet



Photo 2. Poor channel drainage results in nonuniform growth and muddy spots. Defects are easy to see after a significant runoff event.

riser and verify the holes are low enough for good drainage.

Sediment can accumulate at the outlet end of the pipe drain. Remove this sediment as needed to permit good drainage. Repair any damage to the pipe inlet riser and outlet promptly.

Waterway. The vegetated waterway must have adequate depth and cross-sectional area to easily carry terrace discharges. Sediment will deposit in the waterway, usually below the terrace outlets, and must be removed periodically to maintain the cross-section shape and waterway capacity. For cool season grasses, fertilize the waterway to maintain a dense, healthy grass cover. Mowing is usually required to control weeds, to control trees and brush, and to help maintain desirable grass species. Mowing helps prevent the slowing of water and reduces the accumulation of sediment. Hay from waterways is a good source of production from the field. Quickly fill gullies and eroded areas in the waterway and reseed (or sod) to prevent erosion. Remove harvested hay to prevent smothering of vegetation.

Reshaping the terrace

Terrace maintenance can be done with virtually any equipment that will move soil. Some commonly used tools include moldboard plow, disk plow, one-way,

belt terracer, bulldozer, front blade, three-point blade, towed straight-wheeled blade, towed terracing blade (pull-type grader), scraper, motor grader (road-grader), three-point ridging disk (terracing disk) and whirlwind terracer.

This publication discusses procedures for the most common farm implements: the plow or one-way. To use other equipment, seek advice from manufacturers or other users, or experiment to find what procedures work best.

The number of passes required for maintenance depends on the size of the tool, the depth of operation, travel speed (which controls distance of throw), and the amount of soil to be moved. The plow or one-way throws soil further at higher speeds, so a minimum ground speed of 5 mph is suggested, but 6 mph or more is better. This speed should be achieved as the equipment moves through loose soil.

The primary objective is to move soil from the channel to the ridge. Work done on the terrace back slope or cut slope above the channel may help maintain or improve shape, but does little to add significant ridge height or channel capacity.

The two-way (rollover) plow is ideal for terrace maintenance because it allows greater flexibility. The two-way plow usually can achieve the desired shape with fewer passes than the conventional plow. Turn the soil in one direction to counteract erosion or turn it in either direction to clear the channel or raise and widen the terrace ridge.

Maintenance procedure controls terrace shape.

Assess what needs to be done before beginning maintenance, compare the existing cross-section shape with the desired shape and size, and determine where soil should be removed and where it should be placed. Back furrows are placed where more soil is needed, while dead furrows are located where soil needs to be removed. In this way, passes or sets of passes with the equipment are located to achieve the desired results.

Terrace dimensions can be changed by carefully planned placement of back furrows and dead furrows. Large changes in



Figure 4. Double back furrow.

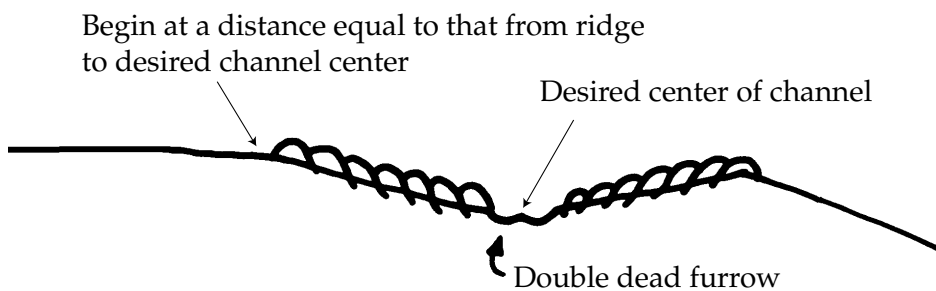

Figure 5. Enlarging and widening the terrace channel

dimension and shape require several sets of passes with the tools or reshaping with earth-moving equipment. Remember, select the segment length and cross-sectional size to fit the current and future tillage, planting, and harvesting equipment size.

The number of rounds or passes with maintenance equipment depends on the size of equipment and the desired size and shape of terrace sections. If in doubt, it is better to make extra passes than to stop too soon. Remember, the loose soil will settle considerably.

When a one-way is used for maintenance, begin with the dead furrow at the desired channel location and move toward the ridge the width of the throw. Each pass moves soil closer to the ridge. Several passes may be required, depending on implement and terrace size. Smooth the low spot that develops in the tractor print with a final half swath, using the one-way's leading or trailing edge.

Plowing the ridge. The terrace ridge is raised and widened by plowing up from both sides as shown in Figure 4. The back furrows are placed on top of the ridge, and the dead furrows are placed at the desired center of the channel and at the toe or beyond on the backslope. Avoid making a depression on the back-slope; vary where the dead furrow is plowed with each maintenance. Plowing the ridge is recommended for maintaining or adding ridge height for both flat and steep field slopes. To make the ridge wider and not so sharply peaked, the back furrows should come together, but not overlap.

Correct a narrow peaked ridge resulting from too few passes by moving the plow over only one or two bottom widths with each pass. This process requires many passes. Continue until the dead furrow is the desired distance from the ridge. For the three-segment shape, locate the back and dead furrows in the same place each year, keeping the cross-section uniform in size and shape. Vary the back furrow and dead furrow

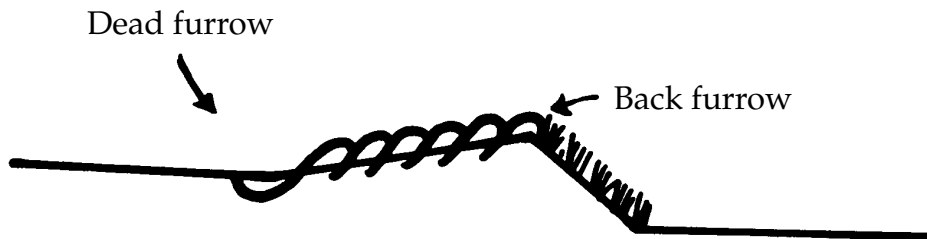

Figure 6. Working up a grass-back terrace.



Photo 3. Plowing up the ridge is usually adequate maintenance when the terraces are not seriously worn down.

locations each year to maintain the rounded shape of the channel and ridge for the large smooth section.

If the ridge is large enough, it is neither necessary nor advisable to plow the terrace back slope. Plowing the back slope leaves the steepest area on the field unprotected and subject to erosion. It is better to return empty than waste fuel unnecessarily stirring soil on the back slope.

Plowing out the channel. Sometimes even when the ridge is large enough, the channel can have inadequate capacity. To enlarge and widen the terrace channel, plow out to both sides as shown in Figure 5. Back furrows are placed on the ridge and on the uphill cut-slope side the same distance from the desired center of the channel. Begin at a distance equal to that from ridge to desired channel center. A double side-

by-side dead furrow should result at the desired channel center. Locate the plow back furrow on the ridge and the dead furrows in the desired channel bottom to achieve and maintain the desired shape. Vary the back furrow location to avoid leaving a large ridge on the cut slope.

Plowing out the channel periodically is recommended for steeper slopes to

help maintain adequate channel capacity. Alternating between plowing the channel out and plowing the ridge up from one time to the next is a good practice.

Maintaining the grass-back section

The grass-back terrace section is best maintained with a two-way plow, which allows plowing from the channel to the ridge as shown in Figure 6. If a conventional plow is used, it is best to travel back empty to obtain the same results as the two-way plow. This practice also works well for maintenance on a broad based terrace where ridge and channel are large enough and the height just needs to be maintained.

Maintaining the flat channel terrace

This terrace is used in the dry areas of western Kansas and catches runoff from the slope. The terrace bottom must be level to ensure uniform distribution of water. Never leave back furrows or dead furrows in the bottom of the terrace. Because of the large capacity of this terrace shape, a maintenance interval of several years should be adequate to maintain terrace height. These terraces are most easily maintained with a two-way plow as shown in Figure 7a. A conventional plow can be used, but several empty returns must be made to achieve the same results as a two-way plow. Another option is to plow a considerably larger area to avoid leaving a dead furrow in the level channel bottom (see Figure 7b). Smooth with a land plane or land leveler,

preferably with laser grade control, every 5 to 8 years to help maintain a channel without depressions or high spots. Maintaining a level channel bottom is important for good water distribution across the flat surface.

Restoring a seriously deteriorated terrace

When the terrace height has seriously deteriorated, it is subject to frequent overtopping and erosion. The normal maintenance practice of a single set of passes plowing the ridge up annually will not restore enough capacity in this situation. Multiple sets of passes are required (as when building terraces) to move enough soil to adequately restore height and capacity.

Combining the practices of first plowing up the ridge and, then plowing out the channel is recommended to add about 3 to 4 inches (after settling) to the height. This practice results in double plowing of the terrace front slope, shown in Figure 8. For the second set of passes, the plow turns and throws the soil better if it can be set a little deeper so undisturbed

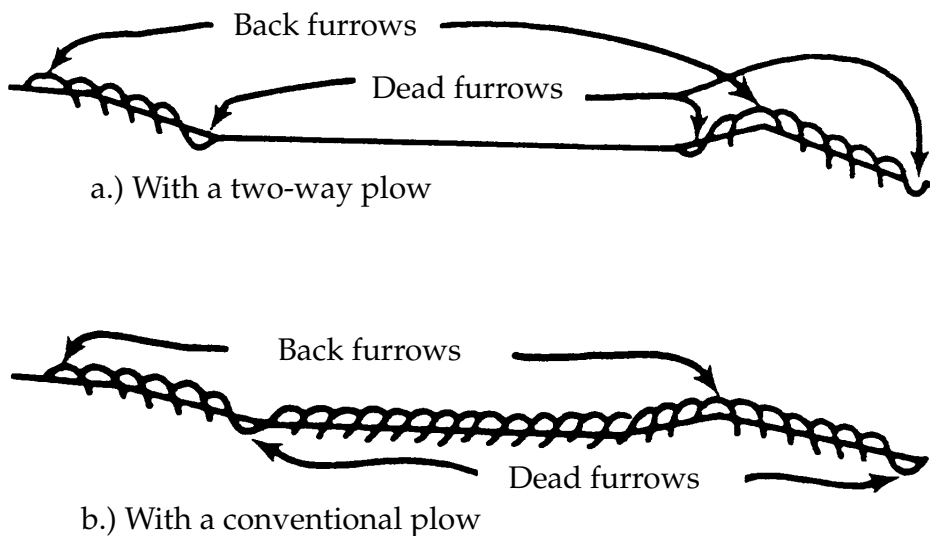

Figure 7. Method for working up a level flat-channel terrace.

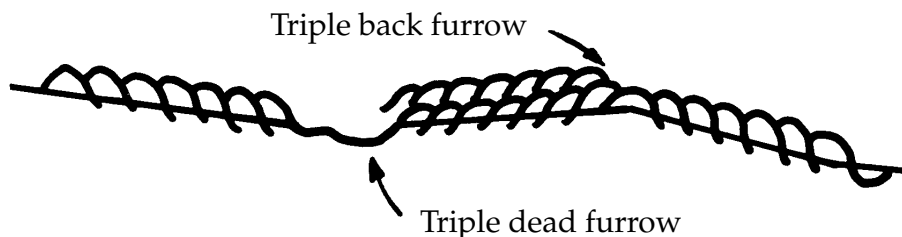

Figure 8. To restore deteriorated ridge height and capacity: First, plow up the ridge as in Figure 4; second, plow out the channel as in Figure 5.

soil is cut. Remember to keep speed above 5 mph (preferably 6 mph or more) when plowing, especially in loose soil. Repeating this practice several years in a row will restore the ridge height and channel capacity so routine terrace maintenance can follow.

Cropping systems to extend longevity

When silt bars and sediment deposits accumulate frequently in a terrace channel, excessive erosion is the cause. This indicates a need for a change in tillage and cropping practices. Conservation tillage and crop rotations that retain crop residue on the surface will reduce erosion substantially. It also will reduce the frequency of terrace maintenance.

Contour farming. Performing tillage and planting operations parallel to terraces helps reduce demand on the terrace design. It lengthens the time water stays on the field after a storm, providing greater opportunity for infiltration and storage of precipitation. Contour farming minimizes the crossing of terraces and associated damage by equipment. Conversely, following field boundaries without regard to contours knocks down the terrace ridge, fills the channel, and accelerates erosion. Adopting contour farming operations should reduce terrace maintenance by 50 percent or more.

Conservation farming systems. When terraces are totally eroded and need major repair, usually the current tillage system needs evaluation. In some cases, ridge-till might replace terraces. By building the ridges on field contours, a system of mini-terraces is created. Place these ridges on a 1 to 2 percent grade to facilitate drainage. Field drainage should be into a protected area such as a grass waterway. In fields with slope less than 5 percent, adopting intensified no-till planting systems can provide adequate protection from erosion. High levels of surface residue reduce and slow runoff substantially. Many no-till producers find existing terrace systems require little maintenance. Although runoff still occurs, there is very little soil movement in a no-till system.

Summary

Terraces need regular maintenance to continue to function. Annual inspections and general observations during the course of seasonal field operations and after large runoff events can help pinpoint problems before catastrophic failure occurs and gullies form.

Terraces should be considered only a part of an overall erosion control plan. Use of conservation farming methods, especially residue maintenance, complements erosion control structures and has been shown to be both economically and environmentally sound.



Photo 4. *The cross-section shape of a terrace more than 10 years old depends on practices used to maintain the terrace. After maintenance, this terrace has a good shape with adequate width and height, and a smooth channel and ridge.*

Use this publication as a guide to rebuild and reshape terraces to protect the significant investment made. There are many different ways of doing maintenance. The authors have seen several different tools used and varied practices. We have known people who have purchased an inexpensive secondhand plow and others who purchased new single-use tools for maintenance. Experiment with available equipment until you discover something that works well for you.

G. Morgan Powell
Extension Water Quality Engineer

Kent A. McVay
Extension Specialist
Soil and Water Conservation

Brand names appearing in this publication are for product identification purposes only. No endorsement is intended, nor is criticism implied of similar products not mentioned.

Publications from Kansas State University are available at: www.bookstore.ksre.ksu.edu.

Contents of this publication may be freely reproduced for educational purposes. All other rights reserved. In each case, credit G. Morgan Powell and Kent A. McVay, *Terrace Maintenance*, Kansas State University, July 2004.

Kansas State University Agricultural Experiment Station and Cooperative Extension Service

C709

July 2004

K-State Research and Extension is an equal opportunity provider and employer. Issued in furtherance of Cooperative Extension Work, Acts of May 8 and June 30, 1914, as amended. Kansas State University, County Extension Councils, Extension Districts, and United States Department of Agriculture Cooperating, John D. Floros, Director.