

Back Injury Prevention

**For the Fruit and Vegetable
Preserving and Specialty Foods
Manufacturing Industry**

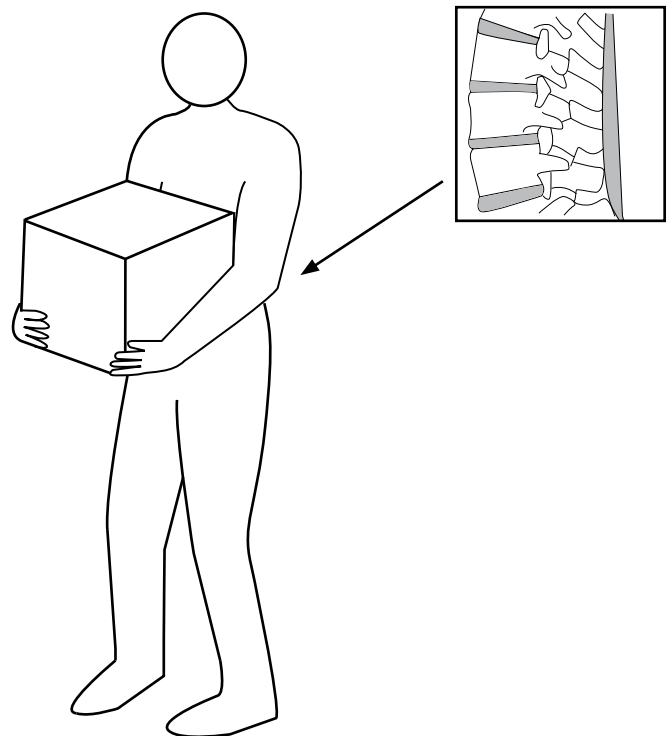

KSTATE Research and
Kansas State University Extension

*“Knowledge
for Life”*

Back Injury Prevention

Contents

Introduction What's Inside?	3
Lesson 1 Understand Your Back and Back Pain	4
Lesson 2 Prevention and Relief of Back Pain.....	9
Lesson 3 Safe Work Practices.....	20
Lesson 4 Healthy Back Care	29
Conclusion	33
Quiz Yourself Solutions.....	35

Written by:

Mitch Ricketts, Coordinator, Health, Safety and Environmental Quality, K-State Research and Extension

Kristy Wieland, Information specialist

Disclaimer

This material was produced under grant number 46G4-HT13 from the Occupational Safety and Health Administration, U.S. Department of Labor. It does not necessarily reflect the views or policies of the U.S. Department of Labor, nor does mention of trade names, commercial products, or organizations imply endorsement by the U.S. government.

This booklet was produced by K-State Research and Extension, Kansas State University, Manhattan, Kansas.

The information in this publication has been compiled from a variety of sources believed to be reliable and to represent the best current opinion on the subject. However, neither K-State Research and Extension nor its authors guarantee accuracy or completeness of any information contained in this publication, and neither K-State Research and Extension or its authors shall be responsible for any errors, omissions, or damages arising out of the use of this information. Additional safety measures may be required under particular circumstances.

What's Inside?

The information and advice in this booklet will help you understand the causes of back pain. It will also provide tips for avoiding injury and demonstrate stretches and activities you can do to prevent back injury and relieve back pain.

Use this booklet along with hands-on safety training. This booklet is not meant to replace your doctor's recommendations.

Lesson 1

Objectives

1. Name common sources of back pain.
2. Recall when muscles are likely to be injured.
3. Recognize when to see a doctor.

Understanding Your Back and Back Pain

Nearly all adults experience back pain at some point in their working lives. This common problem is one of the leading causes of lost work days and individual suffering. If steps aren't taken to maintain a healthy back, the pain can become long-term and disabling.

How Does Your Back Work?

A basic understanding of how the back works can help you understand why it is prone to injury and what you can do about it.

Spine

Bones

The bone portion of your back consists of 24 vertebrae. They are stacked one on top of another to form a long and stretched S-shaped curve with two curves to the front and one to the back.

Discs

The discs separate the vertebrae. They work to absorb shock and keep the vertebrae from rubbing against each other.

Facet Joints

Each vertebra has a facet joint that allows you to bend and move your back. The facet joints are held together by ligaments.

Ligaments

These bands of tough tissue support the spine and help to keep it in place.

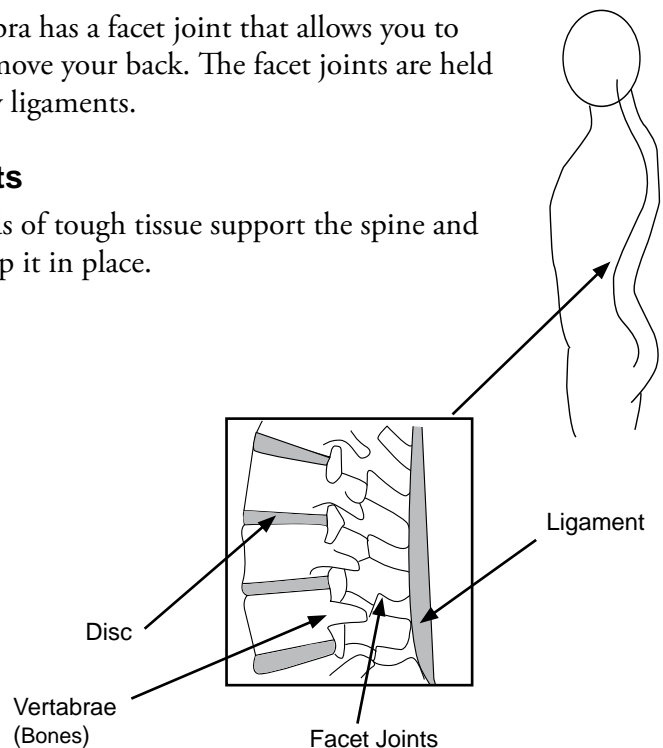

Spinal Cord and Nerves

The spinal cord is located within the spinal column. It is composed of nerve bundles that carry messages throughout your body.

Muscles

Your muscles support the vertebrae of the spine from all sides. The following four muscle groups are involved in the movement of your back and support of your spine.

Muscle Groups

1. **Back** muscles are located in two columns on either side of your spine, and are critical for movement and weight bearing.
2. **Stomach** muscles begin at the rib cage and connect to the pelvis. They serve to support the abdominal cavity and are important in protecting the lower back from injury.
3. **Hip Flexor** muscles attach at the spine and travel across the pelvis to the thigh bones, allowing you to bend forward.
4. **Side** muscles join the ribs to the hips at the sides of your body. They work to help you rotate and bend.

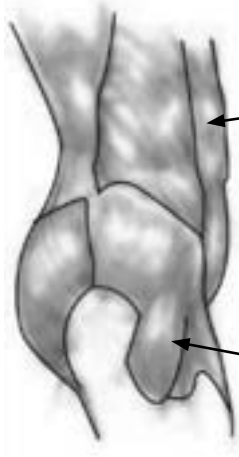

Stomach, Side and Hip Muscles
(side view)

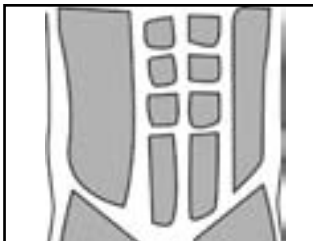

Stomach Muscles
(front view)

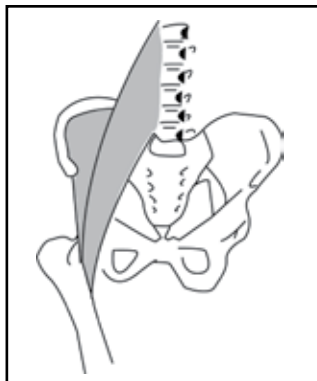

Hip Flexor Muscles
(front view)

The stronger and more flexible your muscles are, the better your chances of avoiding injury.

Back Muscles



Most back pain is caused by overuse or straining of the muscles and ligaments. Back pain can usually be prevented with safe work practices, stretching and strengthening activities.

Back Components:

Spine

- ▶ Bones
- ▶ Discs
- ▶ Facet Joints
- ▶ Ligaments

Muscles

- ▶ Back
- ▶ Stomach
- ▶ Hip
- ▶ Side

Back Pain:

Sources

- ▶ Muscle
- ▶ Discs and Nerves
- ▶ Ligaments and Facet Joints

Types

- ▶ Short-term
- ▶ Long-term

What is Back Pain?

Back pain can have many causes. While the pain may seem to be caused by one single event, the real cause is often the combined result of years of straining, repetitive tasks, awkward postures, lifting, twisting and the weakening of back and stomach muscles. These small injuries can cause muscle aches, spasms and limited flexibility.

Muscle

Muscle is the most common source of back pain and is most often damaged by strenuous movement that is sudden or unfamiliar. This straining is even more likely if the muscle:

- ▶ lacks strength.
- ▶ is tight and tense.
- ▶ is tired due to a repetitive movement or position that is held too long, such as standing or sitting all day.

Discs and Nerves

Although back pain is more likely to occur from injuries to the muscle, sometimes the pain is the result of an injured disc. If the spine becomes strained or compressed, a disc may become damaged. This damage may put pressure on one of the nerves.

The nerves branch out from the spinal cord between vertebrae. If a nerve is pinched, possibly from an injured disc, you may experience pain and weakness in the back and legs.

Ligaments and Facet Joints

Ligaments and facet joints are most often damaged from stress, overexertion and movement that is sudden and strenuous. An unexpected twist can damage ligaments, cause the facet joint to become irritated and the muscles to spasm. Awkward posture can also put excess strain on the joints making them more likely to become irritated and cause muscle spasm.

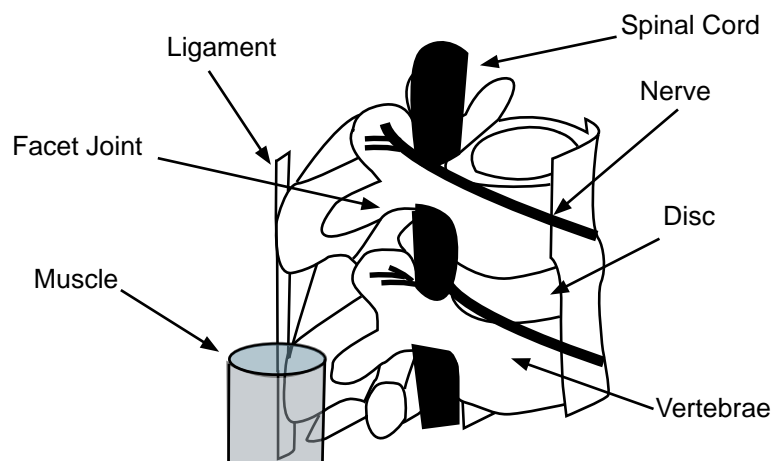

Other Causes

Occasionally, low back pain may be a sign of a more serious medical problem.

See a Doctor When:

- ▶ Your pain is the result of a specific injury.
- ▶ Pain is so bad you can't move.
- ▶ Pain goes down your leg.
- ▶ Your leg, foot, groin or rectal area feel numb.
- ▶ You have fever, nausea, stomach pain, weakness or sweating.
- ▶ You lose bladder or bowel control.
- ▶ You don't notice improvement in back health after two to three weeks.

If you experience any of these symptoms, you should contact a doctor immediately.



Types of Back Pain

Short-term

Short-term low back pain is very common and lasts no longer than three months. Most of this minor back pain is the result of overuse or straining of the muscles or ligaments. If properly treated, the pain will be gone within a few weeks.

Long Term

Long-term back pain lasts more than three months and may cause severe disability.

In the next lesson, you will learn how to stretch and strengthen your back and other muscles. Proper stretching and strengthening activities may prevent back injury and relieve pain.

Quiz Yourself

(Answers can be found on page 35.)

Use the list of words to fill in the blanks:

vertebrae

muscle

strength

doctor

awkward

1. _____ postures can strain the back.
2. The most common source of back pain is the _____.
3. Back muscles are more likely to be injured when they lack _____.
4. Your back muscles support the _____ from all sides.
5. If you experience progressive weakness in the legs, contact a _____ immediately.

Prevention and Relief of Back Pain

Why Stay Active?

A common and sometimes harmful myth is that all activity should be avoided when experiencing back pain. Many people are afraid that activity will only make the pain or injury worse.

For most back problems, light activity helps speed the healing process. Gradual activity and stretching may reduce future back pain and reduce the likelihood of re-injury.

How Stretching Helps

You can minimize and prevent back pain with stretches that make the muscles in your back, stomach, hips and thighs flexible and strong. Stretching activities also:

1. Reduce Injuries

When you stretch, muscles relax and lengthen. Relaxed muscles withstand stress better than tight ones. Typically, the more flexible you are, the less likely you are to suffer back pain.

2. Improve Performance

Stretching can increase your range of motion, making you more effective at work and in other activities. It may help you become more efficient in performing your daily tasks.

Before starting any new exercise, consult your doctor. Unless directed by your doctor, do not attempt the following exercises if you are pregnant or suffer from back pain.

Lesson 2

Objectives

1. Discuss why stretching and strengthening can help prevent back injury.
2. Identify correct stretching techniques.

Staying active and continuing your usual activities, within tolerable pain limits, helps recovery.

Activities for Prevention and Pain Relief

You can prevent and relieve back pain with simple stretching and strengthening activities.

Stretching

Although stretching should focus primarily on the the back, it is also important to stretch and strengthen the stomach, arms and legs. For example, the hamstring muscles, located at the back of the upper thigh area, play a large role in lower back function. Tightness in the hamstrings limits motions of the pelvis and can place undue stress on the lower back.

Strengthening

Strong muscles are essential to a healthy back. If your muscles are weak, back injuries are more likely and recovery is more difficult. Strong hip and leg muscles are important for lifting.

Follow these simple guidelines:

- ▶ Stretch until a mild tension is felt, then hold for 5-10 seconds.
- ▶ Hold the stretch steady and do not bounce.
- ▶ Never stretch to the point of numbness, tingling or pain.
- ▶ Focus on the activity and avoid any distractions.
- ▶ Take your time – do not rush.
- ▶ Do not hold your breath – breathe freely; relax for better results.
- ▶ Repeat the activity 3-5 times on each side.
- ▶ Make sure you stretch and strengthen all of the major muscle groups which include your legs, arms, shoulders and back.

Perform these simple stretches and strengthening activities daily:

Knees to Chest

(Low Back Stretch)

1. Lie on your back, legs extended.



2. Bring knees to chest. (If you have trouble bringing your knees to your chest, try this stretch lying on your side and bringing your top knee to your chest.)

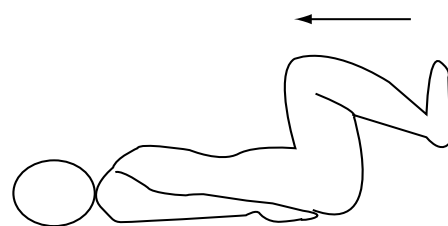

- Place your hands behind your thighs or wrap a towel behind your thighs and exhale as you bring your knees closer towards your chest, hold.

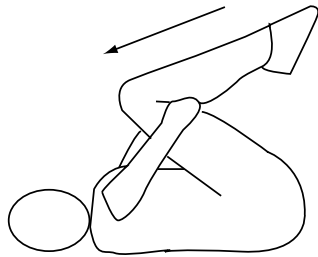

- Release.



- Repeat 3-5 times.

Low Back Stretch

- Lie on your back with legs extended.



- As you inhale, bring right knee towards chest.

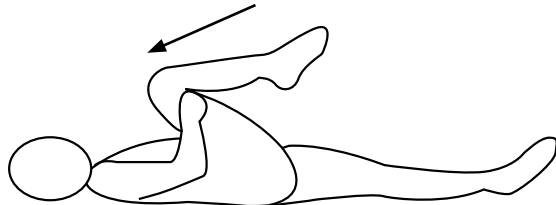

- As you exhale, take right knee across the chest, hold.

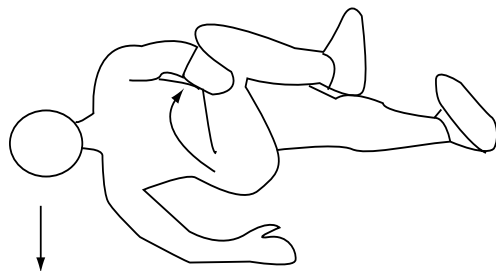

- Release, extending both legs.



Stretching Checklist

- Stretch until a mild tension is felt, then hold.
- Stretches must be held 5-10 seconds.
- Do not bounce – hold the stretch steady.
- Never stretch to the point of pain.
- Focus on the stretch.
- Do not hold your breath.
- Take your time, do not rush.
- Repeat the stretch 3-5 times on each side.

Alternate Low Back Stretches



As you exhale, bring your right knee to your chest and hold. Release, extending both legs. Repeat with left leg.

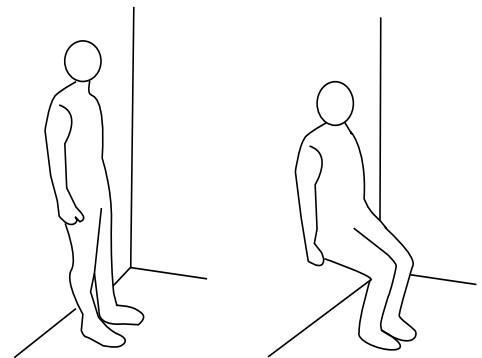

Lean against a wall. Slowly slide down the wall, keeping your knees from extending over your toes. Hold the squat position for 5-10 seconds. Release to standing, repeat.

Low Back Stretch and Strengthen

1. Lie on your stomach with legs and arms straight and extended.



2. Bring your elbows to your sides and your hands under your shoulders. Gently press in to your hands as you slowly lift your chest off the floor.

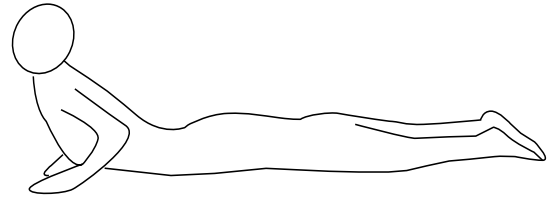

3. Release to starting position.



4. Repeat 3-5 times.

Cat and Dog

(Full Back Stretch)

1. Begin on your hands and knees with hands under shoulders and knees under hips.

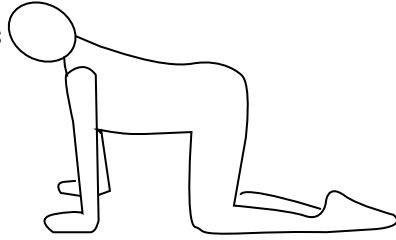

2. As you inhale, look up and drop your stomach towards the floor.

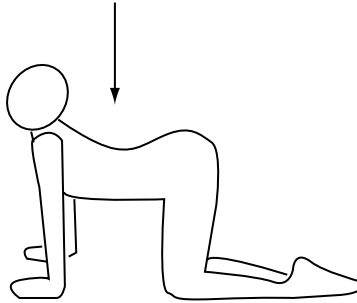

3. As you exhale, release and come back to starting position.

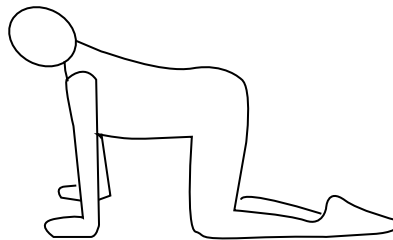

4. Slowly tuck your chin to your chest and round your spine, pull your stomach muscles in and arch your back.

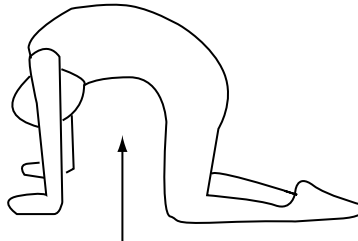

5. Return to starting position.

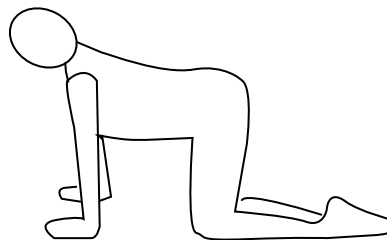

6. Repeat 3-5 times.

Alternate Upper Back Stretch



Begin seated with knees bent, feet flat.

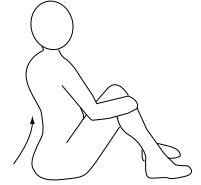

As you inhale, look up and lift your chest.

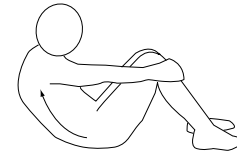

As you exhale, look down, drop your chin to your chest, pull your stomach muscles in and arch your back.



Release to starting position.

Remember to Breathe

Take in a deep breath – hold it – exhale! Your body should feel more relaxed. You need to breathe out as you stretch. If you don't exhale, you'll be holding your muscles tense. Tension during stretching can cause pain.

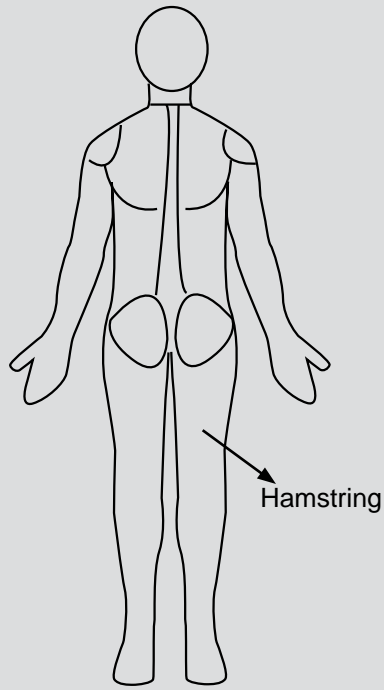

(Rear View)

Tightness in the hamstrings can cause back pain. Perform the simple stretches and strengthening activities in this manual, to keep your back healthy.

Hamstring Stretch

1. Lie on back with knees bent and feet flat.

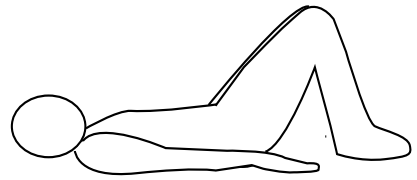

2. Extend right leg straight up, keep left knee bent.

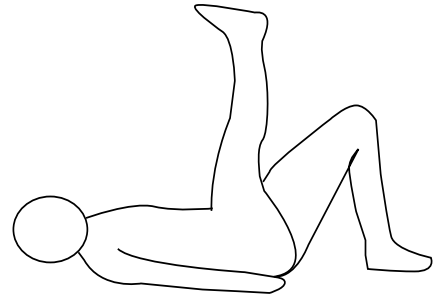

3. Wrap hands or towel around right thigh, as you exhale bring your right leg closer to your chest.

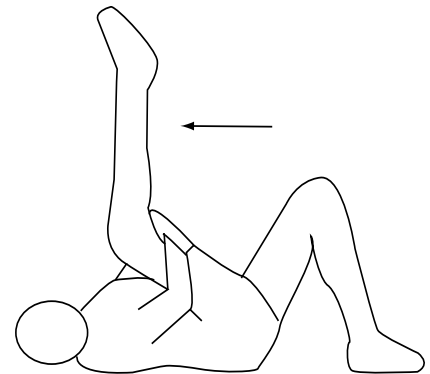

4. Release and place both feet on the floor.

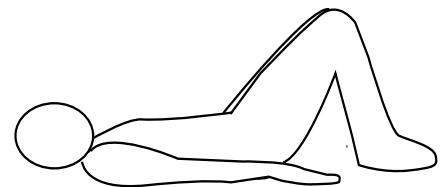

5. Repeat, extending left leg; complete 3-5 times with each leg.

Sit Back

(Stomach)

1. Sit with knees bent and arms extended in front.

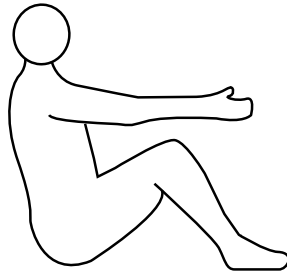

2. Tuck chin to chest, breathe out as you slowly curl back.

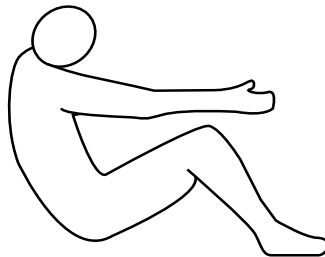

3. Slowly lower all the way to the floor.

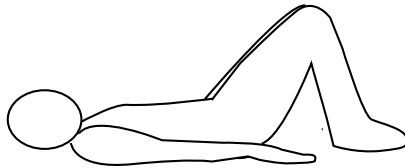

4. Roll to your side and use your elbows to bring yourself up to starting position.

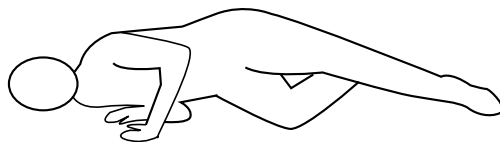

5. Repeat 3-5 times from starting position.

Stretching: How Far is Too Far?

If you feel sharp pain or spasm, stop! Gentle muscle tension is alright when stretching. If you feel uncomfortable, back off!

Be Active

Inactivity, especially when a back injury is involved, can lead to stiff, tight muscles. Stretching may prevent further injury and relieve back pain.

Side and Hip Stretch

1. Stand with hands on hips and stomach muscles pulled in.

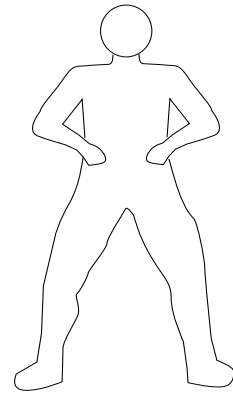

2. Using slow and controlled motions, exhale and lean to your left as you reach your right arm overhead.

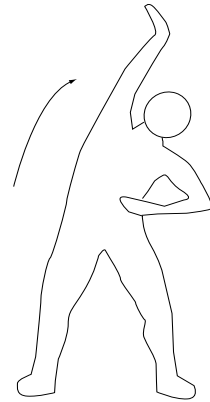

3. Return to center, with hands back on hips and stomach muscles pulled in.

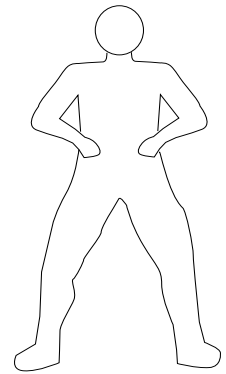

4. Exhale and lean to your right as you reach your left arm overhead and to the right.



5. Inhale and release to standing.

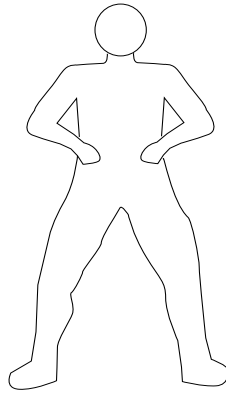

6. Repeat 3-5 times on each side.

Side Leg Lift

(Side and Hip Strengthenener)

1. Lie on your side, bottom arm supporting your head and top arm bent with hand on the floor in front of you.

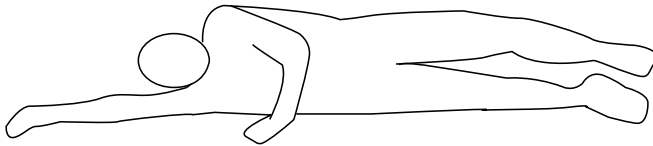

2. With hips stacked, slowly lift your top leg 12" off your bottom leg, hold for 1-3 seconds.

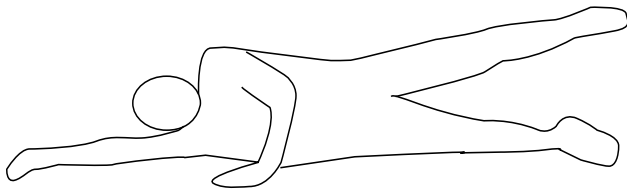

3. Release to starting position.

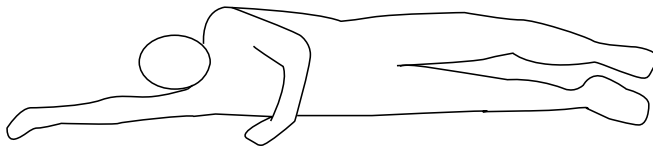

4. Repeat 5-10 times on each side.

Tighten Your Stomach Muscles

You can protect your lower back by simply pulling in your stomach muscles, especially when lifting and bending.

Daily stretching and strengthening may help prevent back pain and injury.

Pelvic Tilt

(Low Back Stretch)

1. Lie on your back, knees bent, feet flat.

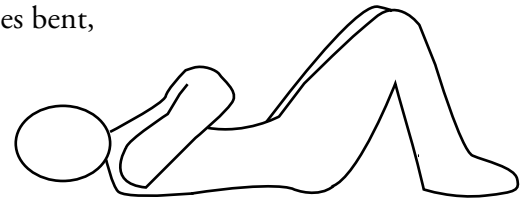

2. As you exhale, press your stomach to the floor and roll your pelvis upward to flatten your back to the floor, hold.

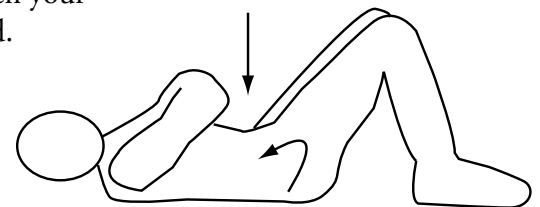

3. Release to starting position.

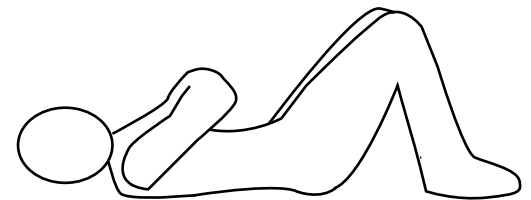

4. Repeat 3-5 times.

Quiz Yourself

(Answers can be found on page 35.)

Use the list of words to fill in the blanks.

stomach
pain
breath
easier
healthy
stretching

1. _____ may help reduce back pain and future injury.
2. If you feel sharp _____ or spasm with stretching, stop.
3. Do not hold your _____ when stretching.
4. You can protect your lower back by pulling in your _____ muscles.
5. Strong muscles are essential to a _____ back.
6. Having strong back and stomach muscles helps make your work _____.

Lesson 3

Objectives

1. Recall risk factors for back injury.
2. Identify safe work posture.
3. Recognize techniques for safe lifting.

Safe Work Practices

To reduce back injuries at work, it is important to find and avoid risk factors that increase your chance of injury. When any of the following occur in combination your risk of a back injury is increased:

1. Awkward posture
2. Overexertion
3. Repetition
4. Fatigue

1. Awkward Posture

Your body posture determines which joints and muscles are used and the amount of force that is generated. Whether standing or sitting, there is a neutral position for your back. Postures that differ from the neutral position increase stress on the back, especially when combined with other risk factors.

Avoid:

- ▶ Strenuous activity while the body is in a twisted or bent position.
- ▶ Repeated bending, twisting and reaching.
- ▶ Bending forward while lifting.

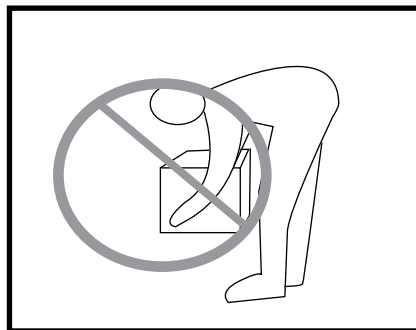

NO

Avoid bending to lift.

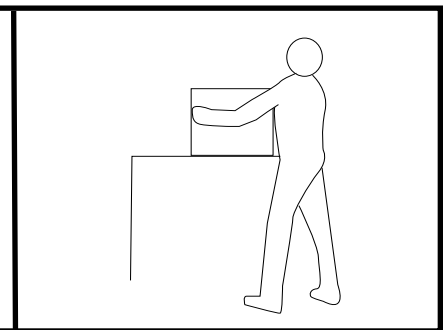

YES

Raise the work to eliminate bending.

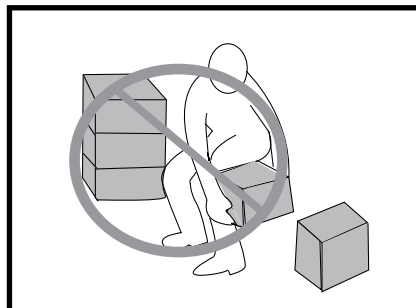

NO

Avoid bending and twisting to turn.

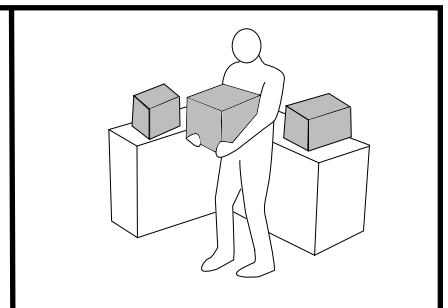

YES

Store materials at waist level and move your feet to turn.

Does the job produce awkward postures?

Strenuous, repetitive motions combined with awkward postures can lead to fatigue and back injury.

How To Reduce Awkward Postures:

- ▶ Change the work height so you can handle the item with your back in a neutral position.
- ▶ Store materials at waist level to avoid bending to lift.
- ▶ Use material handling devices, such as dollies, carts, adjustable-height work stations and lift trucks.
- ▶ Bend the knees, not the back, to lift.
- ▶ Move your feet, instead of twisting, to move materials.
- ▶ Ask a coworker to assist your lift or divide the load.

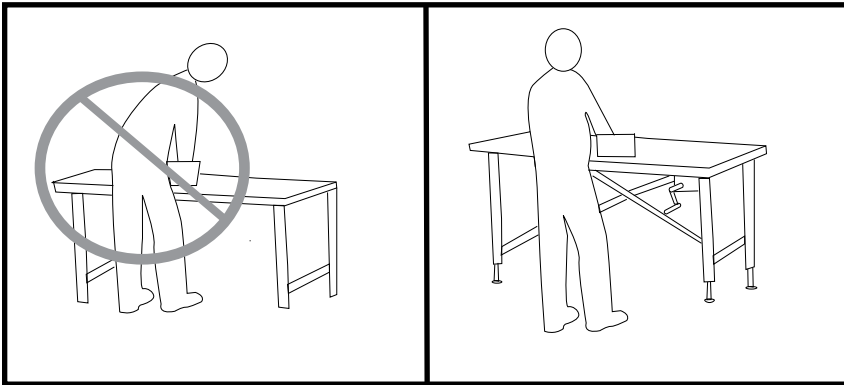

NO

Avoid bending and reaching to get closer to your work.

YES

Use an adjustable-height table so your work is at waist level.

Keep your spine in a neutral position. Bending or twisting for long periods of time can lead to muscle fatigue and back pain. This is why you stretch backwards when you experience back tension. You are trying to adjust your spine back to its neutral position.

Does the job allow for alternating tasks and changing postures?

Avoid holding any position for an extended period of time.

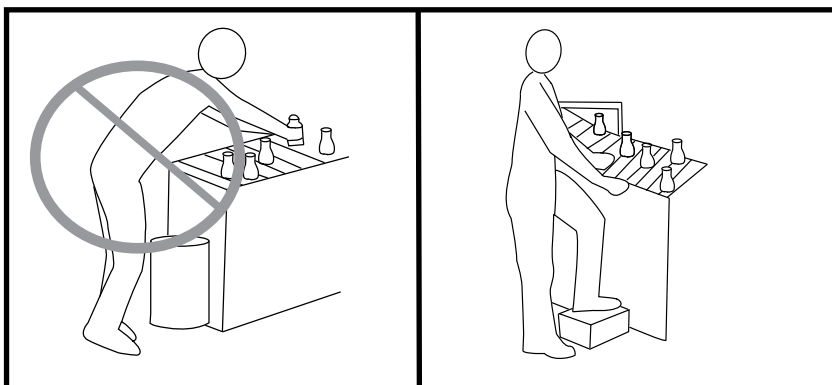

NO

Avoid bending and reaching to get closer to your work

YES

Minimize the distance between you and your work, use a foot rest to reduce stress to the back

What is Neutral Spine?

A neutral spine is like a long, stretched out S, with two curves to the front and one to the back. Your shoulders remain square and your spine is not twisted. When your back is not in a neutral position, the muscles, ligaments and joints have to work harder. Fatigue, discomfort and injury can result.

Depending on your task and your workstation, you may find sitting, standing or another posture appropriate. Alternating different postures allows your back to recover and equalizes the force on all body parts.

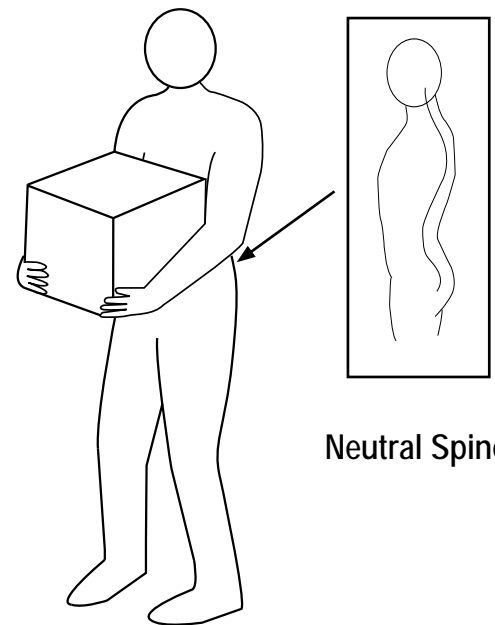

Neutral Spine

Types of Grips

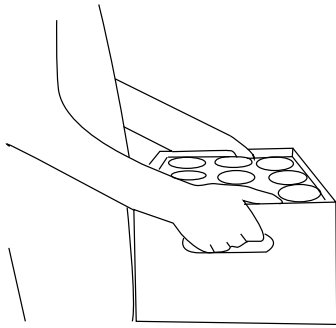

POWER GRIP with handles is the safest grip for moving and lifting.

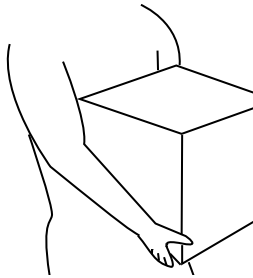

When the container does not have handles, use your palms to grasp from underneath.

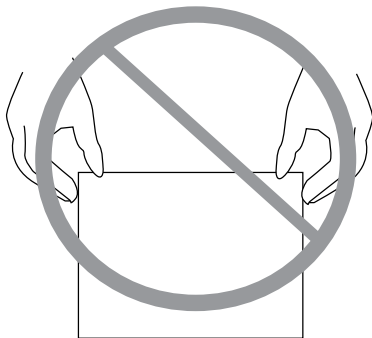

Never Use a PINCH GRIP.

2. Overexertion

Tasks that require forceful exertions place higher loads on the muscles, discs, ligaments and joints and can lead to fatigue and injury.

Your Risk Depends On:

- ▶ Type of grip
- ▶ Weight of an object
- ▶ Type and duration of the task
- ▶ Body posture

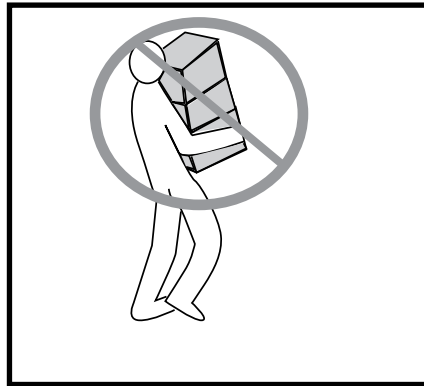

NO

Avoid carrying heavy, awkward loads.

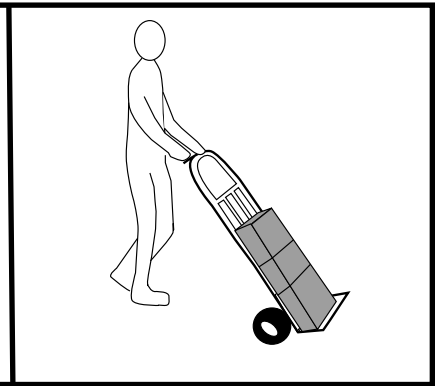

YES

Divide the load and use a device, such as a dolly for transport.

How to Reduce Overexertion:

- ▶ Use material handling devices such as dollies, carts, adjustable-height work stations and lift trucks.
- ▶ Divide the load for safer transport.
- ▶ Push materials rather than lift.
- ▶ Ask a coworker to assist your lift.



NO

Pulling loads places stress on the back, especially when stopping and starting the device

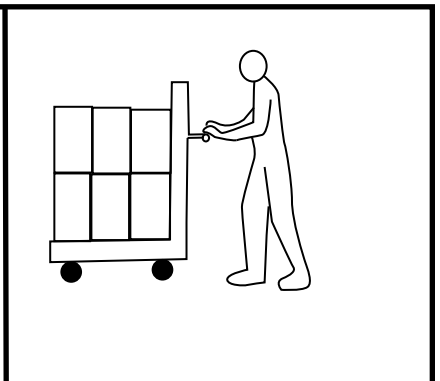

YES

Push rather than pull. Use a well maintained cart with handles at waist to chest height

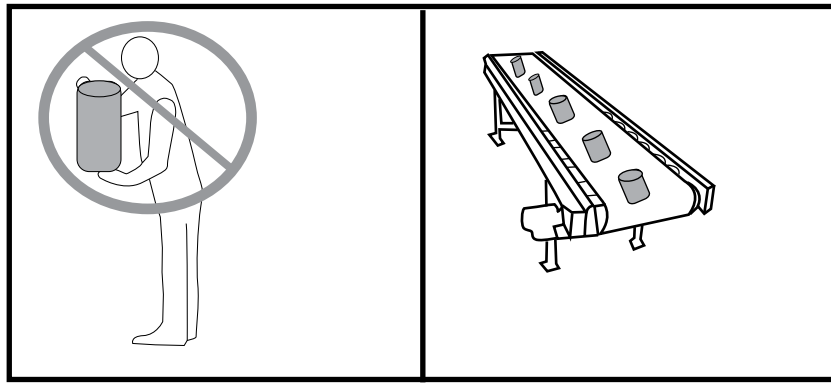

NO

Avoid lifting and lowering heavy materials.

YES

When possible, use a conveyor to transport heavy materials.

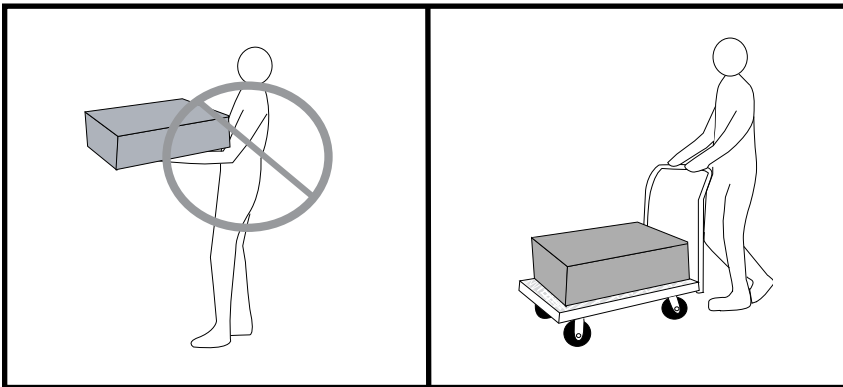

NO

Transporting heavy and awkward materials increases your risk of back injury.

YES

Use a device, such as a cart, to transport heavy or awkward materials.

Workstation Arrangement

Your work station should be arranged to minimize the distance between you and object being handled.

3. Fatigue

Job tasks that require the same muscles or motions for long durations can increase fatigue. In general, the longer the period of work, the longer the recovery or rest time required.

How To Reduce Fatigue:

- ▶ Alternate tasks and postures that use different motions and muscles groups, such as sitting and standing.
- ▶ Take time to stretch during scheduled breaks.
- ▶ Have a chair available so you can break standing tasks with seated.

Does the job...

require repetition? Repetitive motions combined with excessive force and awkward postures stress the muscles and tendons.

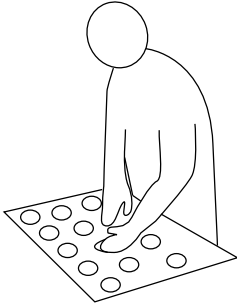

4. Repetition

Repeating the same motions over and over again places stress on muscles and joints. If repetitive motions are frequent or sustained and combined with excessive force or awkward postures, they can cause injury.

Your Risk Depends On:

- ▶ How often the action is repeated.
- ▶ Speed of the movement.
- ▶ Number of muscles involved.
- ▶ Required force to lift or move the material.
- ▶ Body posture.

If motions are repeated frequently, such as every few seconds, and for prolonged periods, such as an 8-hour shift, fatigue and injury can result.



NO

Repetitive motions combined with awkward postures, such as twisting and bending, put you at risk for back injury.

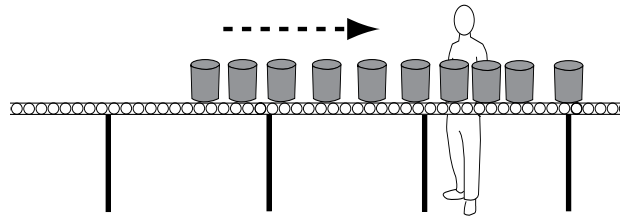

YES

Use material handling devices, such as a conveyor, to reduce repetition.

How To Reduce Injury from Repetition:

- ▶ Alternate tasks and postures that use different motions and muscle groups.
- ▶ Take time to stretch during scheduled breaks.
- ▶ Use material handling devices such as dollies, carts, adjustable-height work stations and lift trucks.

Environment

- ▶ Keep work surfaces and materials dry, to reduce the risk of back injuries from falls.
- ▶ Dress appropriately for the temperature.
- ▶ Wear hearing protection, as needed, to minimize stress from excess noise levels.
- ▶ Use appropriate lighting for maximum visibility at work stations.

Health and Lifestyle

Obesity can increase risk of back injury. The back is designed to carry the body's weight and distribute the loads during activity and rest. When extra weight is carried, the back is forced to carry the burden.

Smoking and stress may also be factors in back injury. When stress causes you to become distracted, you are more likely to neglect safety. Mental distraction can cause fatigue, improper lifting and injury.

Material Handling Devices

Lifting and carrying can be easier and safer with the use of material handling devices. Any machine or equipment used when transporting, lifting or moving any materials, goods or people is a material handling device. If properly used, these devices greatly reduce your risk of back injury by reducing the physical effort required to handle and transport objects.

Is the environment...

wet? A slippery floor or wet object increases the chance of a fall, sudden movement or difficulty gripping.

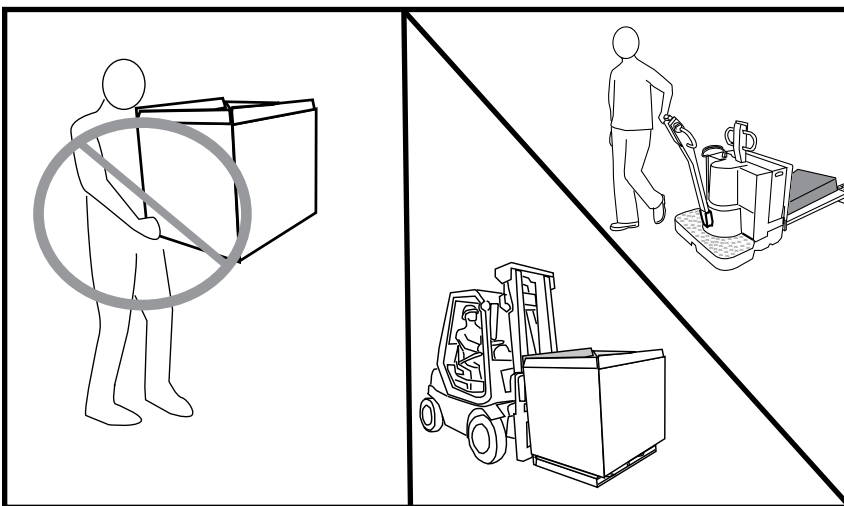

NO

Avoid bending, twisting and lifting heavy materials.

YES

Use a device, such as a pallet jack or lift truck for transport.

Safe Lifting Techniques

1. Plan the lift.
2. Size up the load.
3. Establish a base.
4. Get a good grip.
5. Lift steadily.
6. Keep it close.
7. Move your feet.

Forces On the Back While Lifting Objects

Do not store heavy objects on or near the floor. If you are bending from the waist to lift a 25 pound box from the floor, you are imposing about 700 pounds of force on your back.

Store heavy and frequently used objects off the floor and at waist level. If lifting from the floor is unavoidable, use the lifting techniques outlined in this lesson to minimize back strain or use a material handling device for lifting and transport.

700 pounds of force

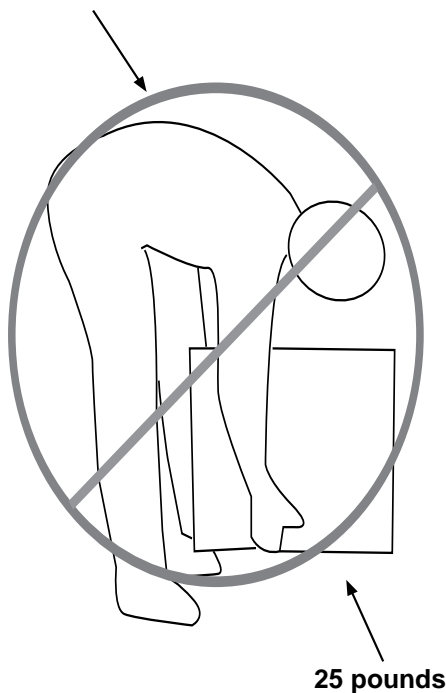

Safe Lifting Techniques

When lifting, know your body's limitations and use proper techniques to protect your back from injury.

Follow These Steps for Safe Lifting:

1. Plan the Lift

Consider all possibilities. Do I need to clear the path? Do I need to reduce the load? Should I use a material handling device? Are there steps, ledges or other obstacles? Will I need to stop for rest?

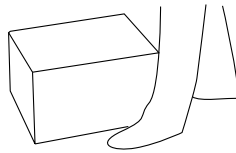

2. Size up the Load

Check the load to see that it is stable and balanced. Before lifting an object, test the weight of the object by lifting a corner. If you are unsure of its weight, use a material handling device.

3. Establish a Base

Use a wide stance, with feet about shoulder's width apart, and one foot slightly in front of the other. This staggered position gives you more stability and reduces the risk of falling. With the load close to your body, bend your knees and keep your heels off the floor.

4. Get a Good Grip

Use your palms to grip the object. Make sure you have an adequate hold before moving. (Refer to page 22, Types of Grips.)

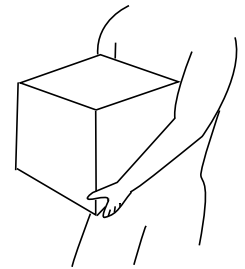

5. Lift Steadily

Use your leg strength to lift in a smooth, controlled manner. Keep your stomach muscles tight and your head and shoulders up. Avoid jerking and twisting motions.

6. Keep it Close

The closer the load is to your body, the less strain on your back.

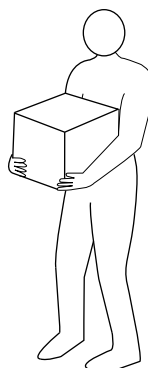

7. Move your Feet

Don't twist the trunk; move your feet to turn.

Quiz Yourself

(Answers can be found on Page 35-36.)

Use the list of words to fill in the blanks.

stress
spine
heavy
wet
recovery

1. Whether you work standing or sitting, keep your _____ in a natural S shape.
2. Avoid _____ lifting to reduce back injuries from overexertion.
3. The longer you work, the longer _____ time your body needs.
4. _____ surfaces increase your risk of back injury from falls.
5. Obesity puts extra _____ on the back.

Circle the proper posture.

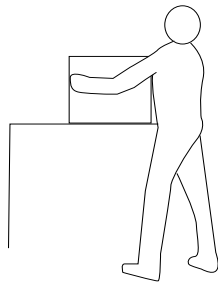
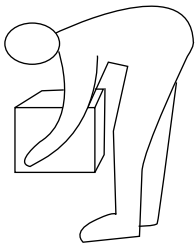

(continued on next page)

(continued from previous page)

Circle the letter of the correct answer.

1. When a load is too heavy, you should _____.
A. lift it anyway
B. use a material handling device

2. Store frequently used or heavy loads _____.
A. at waist level
B. on the ground
C. above your head

3. Always lift _____ and use your leg strength.
A. by yourself
B. quickly
C. steadily

4. If properly used, material handling devices can _____ your risk of back injury from lifting.
A. increase
B. reduce

Healthy Back Care

Posture and a Healthy Back

A neutral spine is like a long, stretched out S, with two curves to the front and one to the back. When your back is not in this neutral position, the muscles, ligaments and joints have to work harder. Fatigue, discomfort and injury can result from awkward posture.



Good Posture - Seated

Awkward sitting postures greatly increase the stress to your lower back.

Good Seated Posture

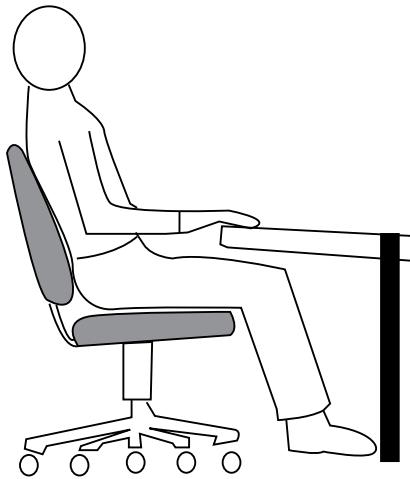

To reduce stress to your lower back:

- ▶ Support the spine along its curve. Use a small pillow for low back support if needed.
- ▶ Lean back slightly.
- ▶ Keep your feet flat and comfortably supported on the floor or with a foot support.
- ▶ Keep knees level or slightly higher than hips to maintain proper circulation.
- ▶ Adjust your seat so your low back is fully supported and you are not leaning forward.
- ▶ Avoid leaving a wallet in your back pocket; it places extra stress on the back and nerves, and can increase back pain.
- ▶ Stretch often and vary positions to decrease fatigue.

Lesson 4

Objective

1. Describe how posture keeps your back healthy.

Good Posture — Standing

Your standing posture while working and performing daily activities has a direct effect on your back health. If you find it difficult to maintain a good standing posture, alternate tasks that require standing with sitting tasks.

To reduce stress to your lower back:

- ▶ Avoid bending or leaning forward to work.
- ▶ When working with heavy objects, keep them at waist level.
- ▶ When performing tasks that require great force, keep the work at waist level.
- ▶ Lighter work should be slightly higher than waist level.
- ▶ Face work “straight on” — avoid twisting.
- ▶ Alternate tasks and postures, such as sitting, standing and working with a foot elevated.

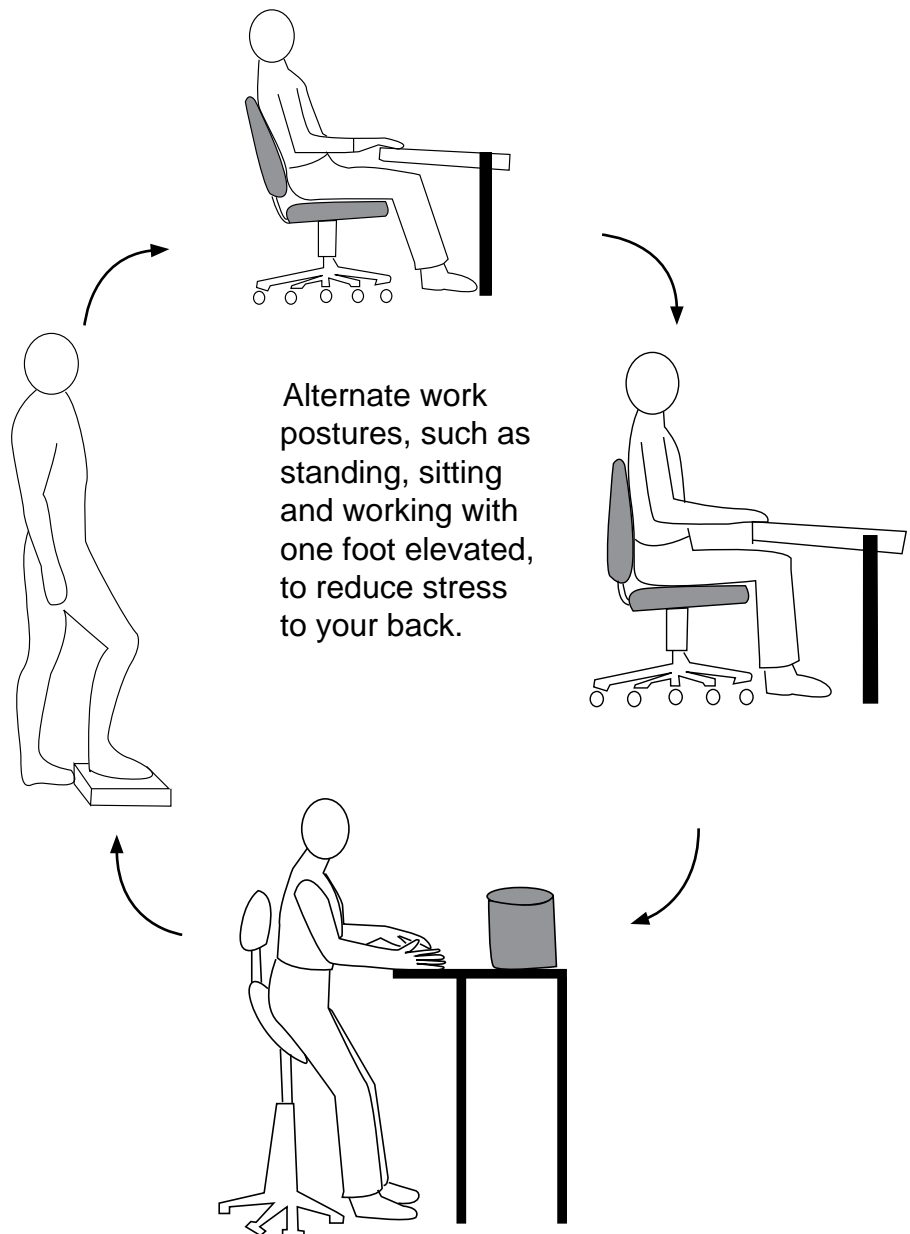

Good Posture - Lying Down

How you sleep is just as important as how you stand and sit. Make sure you have a good mattress that gives firm support along the length of your body but allows you to maintain the natural curve of your spine. It may help to keep one or both legs bent to relieve pain and discomfort. Place a pillow under the knees to prevent twisting.

Good Sleeping Posture

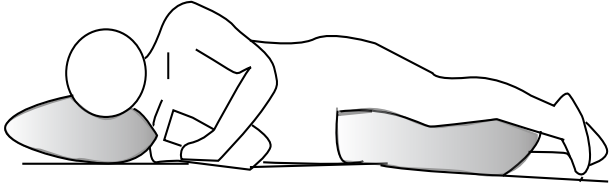

(Side View – Sleeping on Side)

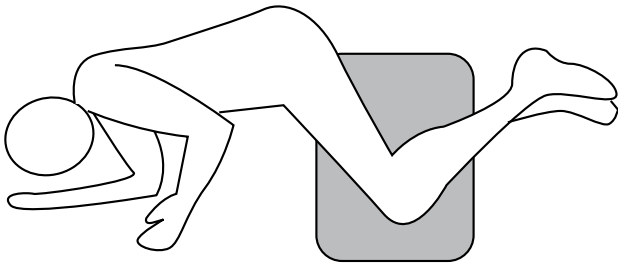

(Above View – Sleeping on Side)

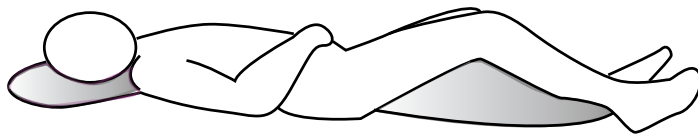

(Side View – Sleeping on Back)

Quiz Yourself

(Answers can be found on page 36-37.)

Use the list of words to fill in the blanks.

sleeping
recovery
spine
fatigue

1. Good posture means your _____ is shaped like a stretched out S with two curves to the front and one to the back.
2. _____ and discomfort can result from awkward posture.
3. The longer you work, the longer _____ time your body needs.
4. Your _____ posture is just as important as how you stand and sit.

Circle the correct answer.

1. When working with heavy objects, keep them _____.
A. on the ground
B. at waist level
C. above your head
- 2 _____ your wallet for better sitting posture.
A. Keep
B. Remove
C. Fill

Conclusion

Preventing a back injury is much easier than treating one. Follow the stretches and strengthening activities outlined in this booklet and practice proper posture and lifting techniques to keep back pain and injuries from happening. Use this information to keep your back healthy. Remember, this booklet is not meant to replace your doctor's recommendations.

Choose!  **safety**

Quiz Yourself

(Answers can be found on page 37.)

Use the list of words to fill in the blanks.

sleeping

prevent

leg

muscles

1. Reduce back injury by lifting with your _____ strength.
2. Repetition or doing the same motion over and over again, places stress on the _____.
3. Daily stretching and strengthening may help _____ back pain and injury.
4. Maintain proper posture when _____.

Circle the letter of the correct answer.

1. Typically, the more flexible you are, the _____ likely you are to suffer back pain.
A. more
B. less
2. The most common source of back pain is the _____.
A. muscles
B. joints
C. discs
3. Stretch until _____ tension is felt, then hold for 5-10 seconds.
A. great
B. painful
C. mild

Quiz Yourself Solutions

Lesson 1, Page 8

Use the list of words to fill in the blanks:

1. Awkward postures can strain the back.
2. The most common source of back pain is the muscle.
3. Back muscles are more likely to be injured when they lack strength.
4. Your back muscles support the vertebrae from all sides.
5. If you experience progressive weakness in the legs, contact a doctor immediately.

Lesson 2, Page 19

Use the list of words to fill in the blanks:

1. Stretching may help reduce back pain and future injury.
2. If you feel sharp pain or spasm with stretching, stop.
3. Do not hold your breath when stretching.
4. You can protect your lower back by simply pulling in your stomach muscles.
5. Strong muscles are essential to a healthy back.
6. Having strong back and stomach muscles can help make your work easier.

Lesson 3, Page 27-28

Use the list of words to fill in the blanks:

1. Whether you work standing or sitting, keep your spine in a natural S shape.
2. Avoid heavy lifting to reduce back injuries from overexertion.
3. The longer you work, the longer recovery time your body needs.
4. Wet surfaces increase your risk of back injury from falls.
5. Obesity puts extra stress on the back.

Circle the better posture:

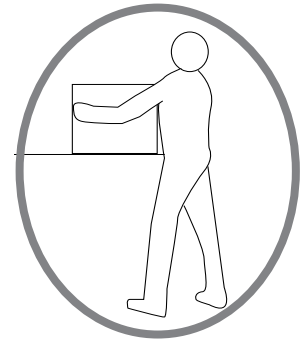
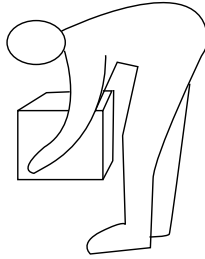

Circle the letter of the correct answer

1. When a load is too heavy, you should _____.
A. lift it anyway
 B. use a material handling device
2. Store frequently used or heavy loads _____.
 A. at waist level
B. on the ground
C. above your head
3. Always lift _____ and use your leg strength.
A. by yourself
B. quickly
 C. steadily
4. If properly used, material handling devices can _____ your risk of back injury from lifting.
A. increase
 B. reduce

Lesson 4, Page 32

Use the list of words to fill in the blanks:

1. Good posture means your spine is shaped like a stretched out S with two curves to the front and one to the back.
2. Fatigue and discomfort can result from poor posture.
3. The longer you work, the longer recovery time your body needs.
4. Your sleeping posture is just as important as how you stand and sit.

Circle the letter of the correct answer:

1. When working with heavy objects, keep them _____.
A. on the ground
 B. at waist level
C. above your head
2. _____ your wallet for better sitting posture.
A. Keep
 B. Remove
C. Fill

Conclusion, Page 34

Use the list of words to fill in the blanks:

1. Reduce back injury by lifting with your leg strength.
2. Repetition or doing the same motion over and over again, places stress on the back.
3. Daily stretching and strengthening may help prevent back pain and injury.
4. Maintain proper posture when sleeping.

Circle the letter of the correct answer:

1. Typically, the more flexible you are, the _____ likely you are to suffer back pain.
A. more
 B. less
2. The most common source of back pain is the _____.
 A. muscles
B. joints
C. discs
3. Stretch until _____ tension is felt, then hold for 30-60 seconds.
A. great
B. painful
 C. mild

Page intentionally left blank.

Page intentionally left blank.



Kansas State University Agricultural Experiment Station and Cooperative Extension Service

MF2762

February 2008

K-State Research and Extension is an equal opportunity provider and employer. Issued in furtherance of Cooperative Extension Work, Acts of May 8 and June 30, 1914, as amended. Kansas State University, County Extension Councils, Extension Districts, and United States Department of Agriculture Cooperating, Fred A. Cholick, Director.